

JSRLF Series

New!

- Air Augment Option
- EPDM seat for low lockup and tight shutoff

Low Flow Pressure Reducing Valves for Bio, Pharma and High Purity Gas Application

The Steriflow JSRLF Series line of low flow pressure regulators have the ability to handle very high pressures and very low flows. These valves are most often used in biopharmaceutical and pharmaceutical research, and production facilities for clean gas flow regulation.

The durable valve body and metal trim components are machined from ASTM A479 316L SST barstock. The standard finish is ASME BPE SF5 (20Ra micro-inch, electropolished), SF1 non-electropolished valves are available. The valve is outfitted with the rugged Jorlon diaphragm and Teflon, PEEK and EPDM seats and seals that are all FDA approved, USP Class VI compliant materials. These materials of construction enable J-Pure to withstand the rigors of SIP and CIP processes if required.



FEATURES

- Top entry design facilitates in-line cleaning and maintenance
- Barstock construction guarantees material integrity and quality surface finish
- Four Cv's between 0.01 and 0.2 and six spring ranges guarantees a valve that will fit your application
- Optimized internal volume
- Proprietary Jorlon diaphragm material provides exceptionally long life
- Soft seat material for ANSI Class VI shutoff

DOCUMENTATION

The following documentation is shipped at no charge:

- Steriflow Unicert, a QC signed Certificate of Compliance for:
 - Material, listing heat numbers with attached MTR's
 - Surface Finish
 - FDA/USP Class VI - for all thermoplastic and elastomers
- Traceability:
 - Each individual product serial number is traceable to the Unicert serial number, heat numbers and attached MTR's

Other documents must be requested at time of RFQ, or order:

- ADI/TSE Free, Certified Test reports, Certificate of Origin.

APPLICATIONS

Ideal for biopharmaceutical and pharmaceutical research and production facilities and equipment for clean gas flow regulation.

High purity purge, or blanket gas
Sparge pressure regulation
Motive force for fluid movement
Clean air, N₂, CO₂, O₂, AR

NOTE: Though not drainable in any installation orientation, this valve can be used on clean steam or non-cavitating liquids with Steriflow engineering application approval.

SPECIFICATIONS

Sizes: 1/4" (DN8), 3/8" (DN10), 1/2" (DN15)

End Connections: ASME BPE, DIN, ISO Tri-clamp, or Tube Weld end; NPT

Gauge Ports: 1/4" FNPT is standard. Contact Factory for Tri-Clamp, VCR, or other alternatives.

Soft Seat Materials for ANSI Class VI Shut-off

- PTFE to +252°F (122°C) continuous or 275°F (135°C) intermittent [not to exceed 15 min. in a one hour period] FDA, USP Class VI
- PEEK to +350°F (177°C), FDA & USP Class VI
- EPDM to +275°F (135°C), FDA & USP Class VI*

* Suggested for low lockup and tight shutoff on no flow or deadheaded blanketing applications

Body Material

- ASME SA479 316L (UNS 31603) is standard. EN 10272:2000 GR 1.4435, AL-6XN®, Hastelloy®C-22 and others are optional.

Diaphragm Material: Jorlon, PTFE™, FDA & USP Class VI

Maximum Inlet Pressure:

- Tube End & Tri-Clamp: 450 psig (31,0 bar)
- NPT: 4000 psig (276 bar) - PTFE or PEEK
- NPT: 350 psi (24,1 bar) - EPDM

Optional Cleaning Specifications

- Clean for Oil-Free
- O2 Cleaning complying with ASTM G93-03 2011 and CGA G-4.1-2009

Note: For a complete ancillary list of all wetted and non-wetted material specifications, please contact Seriflow Valve.

Pressure at Maximum Temperature:

- Tube End and Tri-Clamp: 450 psi @ 350°F (31,0 bar @ 177°C) with PEEK seats; 450 psi @ 150°F (31,0 bar @ 66°C) with PTFE seats; 350 psi @ 275°F (24,1 bar @ 135°C) with EPDM seats
- NPT: 2165 psi @ 350°F (149 bar @ 177°C) with PEEK seats; 3600 psi @ 150°F (248 bar @ 66°C) with PTFE seats; 350 psi @ 275°F (24,1 bar @ 135°C) with EPDM seats

Surface Finish:

- Wetted Internal surface finish: Mechanically polished, and electropolished to ASME BPE SF5, 20 Ra µin (0.5 Ra µm) as standard
- Exterior surface finish: Mechanically polished to 40 Ra µin (1.0 Ra µm) as standard
- Other finishes available upon request

Maximum Pressure Drop:

- Tube End and Tri-Clamp: 450 psi (31,0 bar)
- NPT: 3000 psi (207 bar)

Spring Ranges

- 5 – 50 psi (0,3 – 3,4 bar)
- 25 – 100 psi (1,7 – 6,9 bar)
- 25 – 250 psi (1,7 – 17 bar)
- 75 – 250 psi (5,2 – 17 bar)
- 100 – 450 psi (7 – 30 bar)
- 200 – 750 psi (14 - 52 bar) - NPT only

Flow Capacities: Cv 0.012, Cv 0.03, Cv 0.08, Cv 0.20

Options

- Panel Mounting
- Captured Vent
- Self Relieving - Available with PTFE seats
- Air Augment

JSRLF SERIES LOW FLOW PRESSURE REDUCING VALVE
OPTION DEFINITION

Captured Venting

The captured vent option provides a means to vent downstream, self-relieved gas. To enable this function, a 1/8" FNPT collar is installed on the spring housing. This feature provides a means to safely transport toxic or hazardous, self-relieved downstream gas away from the spring housing via tubing to a safe area.

!VIP! This option must be specified with the Self-Relieving* option if the user wishes to transport self-relieved vented gas to a safe location.

Air Augment

The air augment option provides a means for air loading the valve spring housing for automated control. To enable this function a 1/8" FNPT collar is installed on the spring housing (the same one used for the captured vent option), and a Teflon seal nut is included to seal the adjusting screw threads to prevent leakage. The 1/8" FNPT port is used as the input fitting for loading the spring housing with instrument air to completely automate or augment manual regulator control. An I/P transducer, or a small, self-relieving air set PRV regulator is required (ordered separately) to regulate the instrument air pressure.

***Self-Relieving**

The self-relieving option provides an internal mechanism to vent downstream pressure increase (above the set-point) through the spring housing and out a vent hole in the spring housing. If the gas is toxic, or dangerous - the Captured-Vent option (above) must also be specified. The Self-Relieving option allows for immediate pressure reduction when reducing the set point, provides a means to automatically relieve downstream pressure build-up when flow stops and the valve starts to close (sometimes called Lock-up), and alleviates pressure equalization across the orifice when the regulator is not operating.

!VIP! If selecting the Self-relieving option for a Toxic or Hazardous gas - the Captured Vent option must be selected. You cannot Air-Load if the Self-Relieving option is specified.

Panel Mount

The panel mounted regulator option illustrated on the next page requires a panel cut out of 1-1/2". When this option is specified, the regulator comes fitted with a threaded spring housing, and a panel mounting ring to secure the regulator to the panel.

Gauge Ports - Pressure Gauge

For inlet and outlet pressure gauges (and the gauges) are available as standard options

OPTION ILLUSTRATIONS

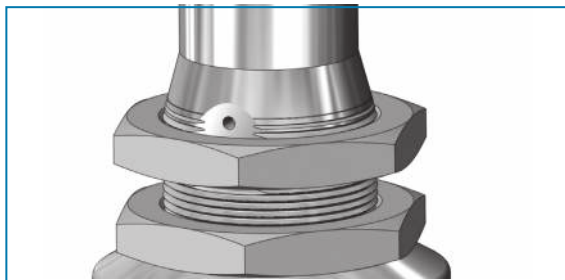

Panel Mount Option

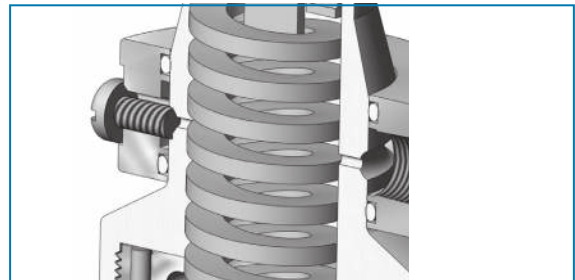

Captured Vent Option (1/8" NPT)

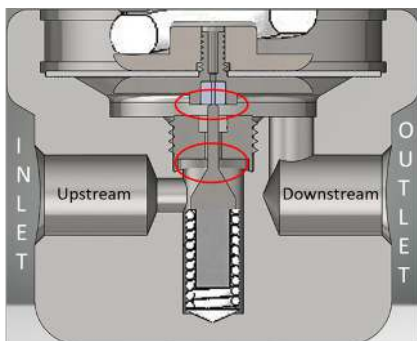

Figure 1: Self Relieving Valve in Closed Position when P2 = set point and flow stops

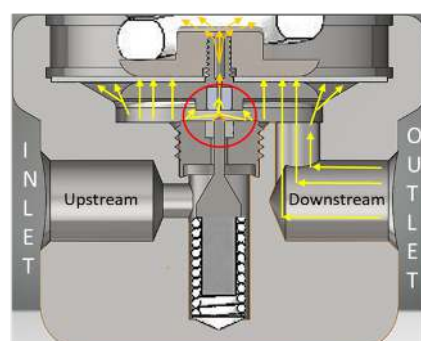
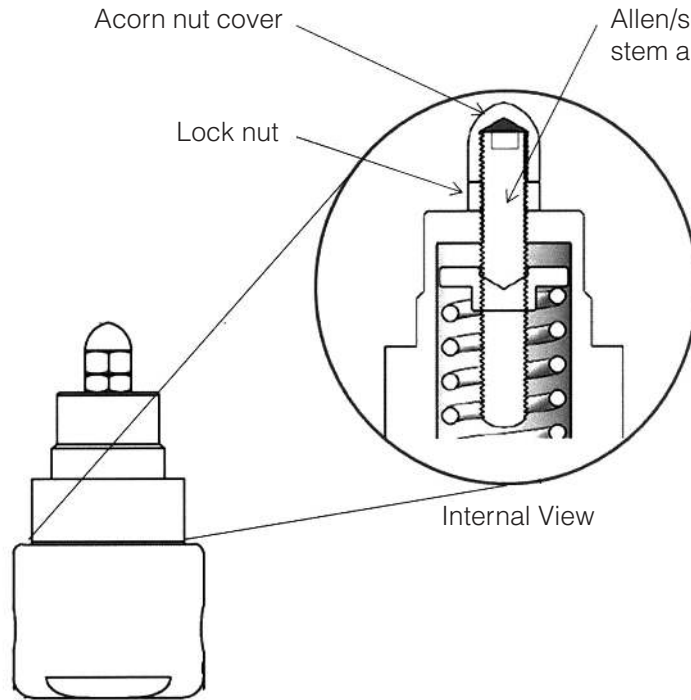

Figure 2: Self Relieving Valve in Closed Position when flow stops and P2 > set point. Showing overpressure release.

Concept illustration of Self-Relieving Option

ANTI-TAMPER OPTION



1. Adjust stem position with Allen wrench
2. Tighten lock nut against bonnet while holding stem position
3. Replace and tighten acorn nut

DIN & ISO TRI-CLAMP DIMENSIONS

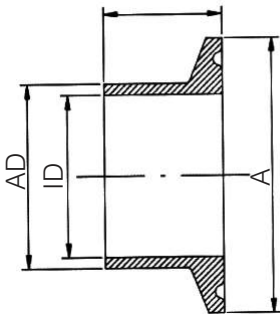

DIN 32676 Row B (ISO 1127)

VALVE SIZE	A	AD	ID
DN15	50.5	21.3	18.1
DN15*	34.0	21.3	18.1
DN20	50.5	26.9	23.7

* with non-standard Tri-clamp face

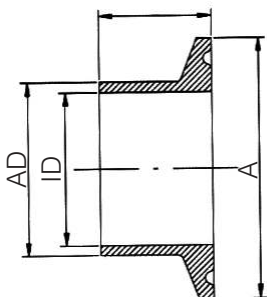

DIN 32676 Row A (DIN 11850)

VALVE SIZE	A	AD	ID
DN15	34.0	19.0	16.0
DN15*	50.5	19.0	16.0
DN20	34.0	23.0	20.0
DN20*	50.5	23.0	20.0

* with non-standard Tri-clamp face

FEATURES & BENEFITS

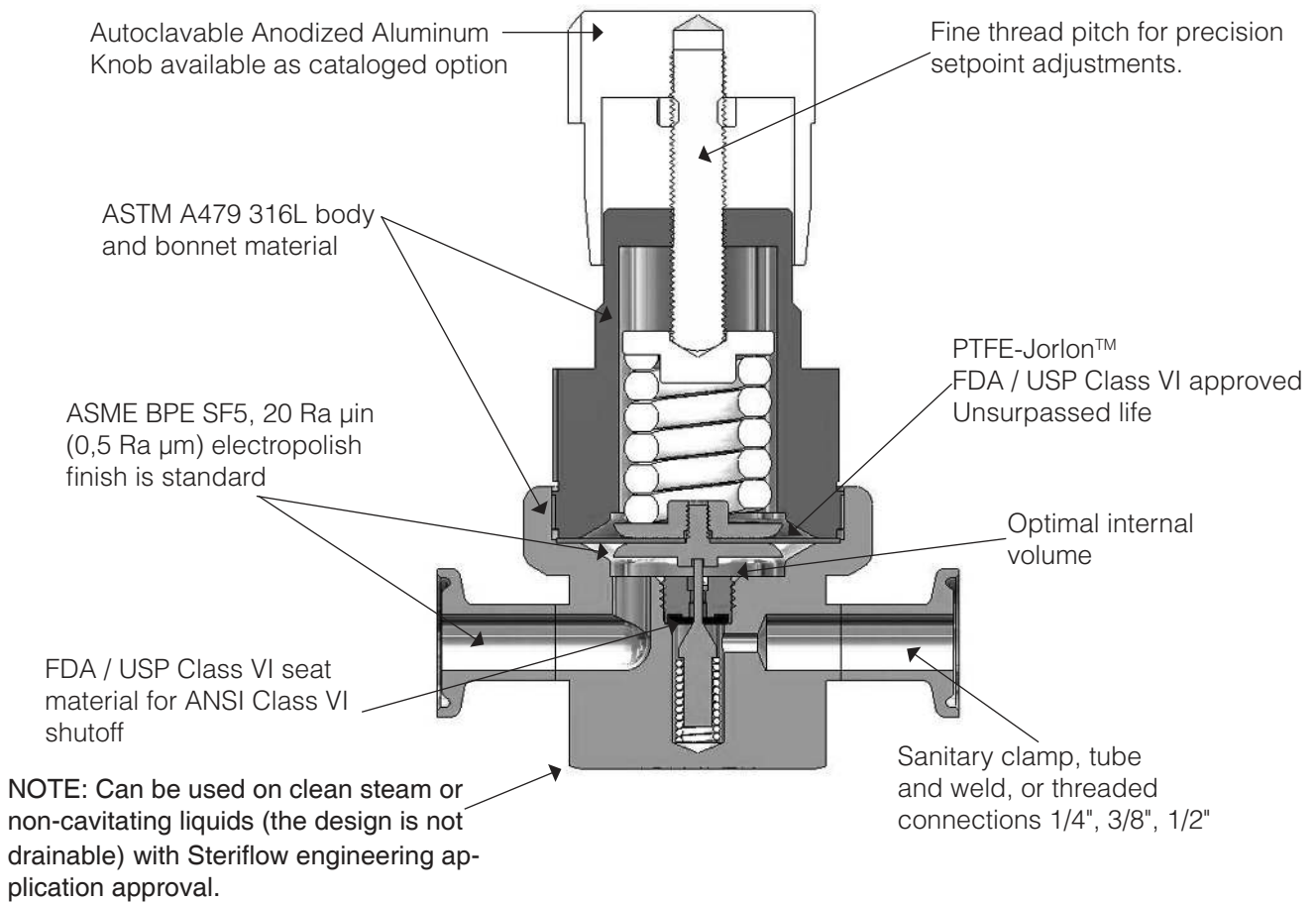

FLOW CONFIGURATIONS/ GAUGE PORTS

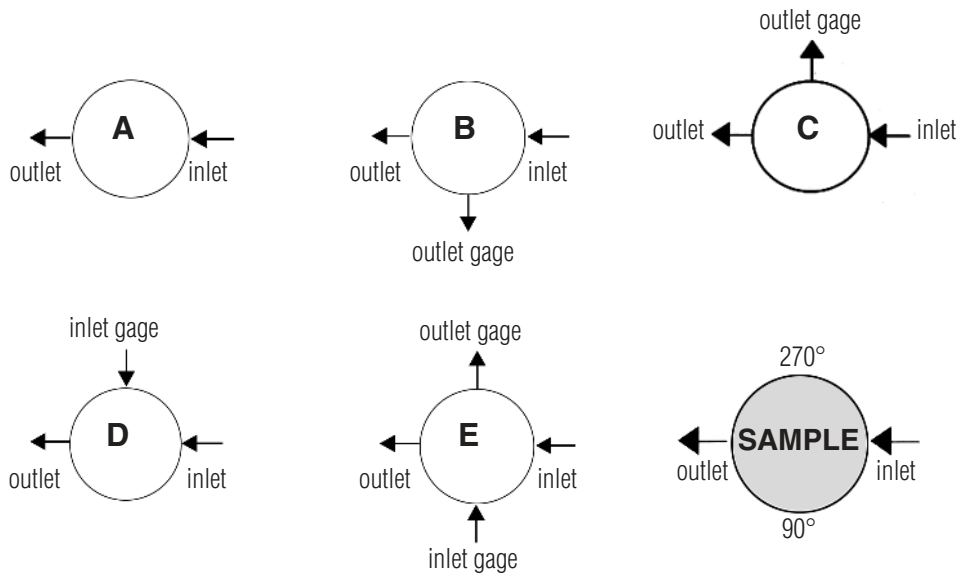

* Gauge ports are 1/4" FNPT as standard. Consult factory for Tri-Clamp, VCR or other connections or porting options.

DIMENSIONS

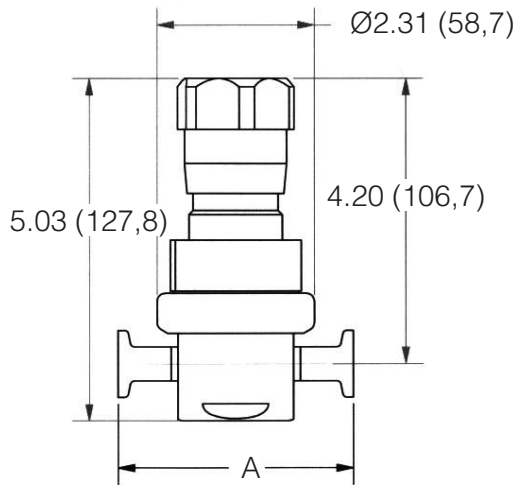

• JSRLF Series with Tri-Clamp Ends, Inches

VALVE SIZE	A	WEIGHT, LBS
1/2"	3.81	4.2
3/4"	3.81	4.2

• JSRLF Series with Tri-Clamp Ends, Metric

VALVE SIZE	A	WEIGHT, KG
DN15	96,8	1,9
DN20	96,8	1,9

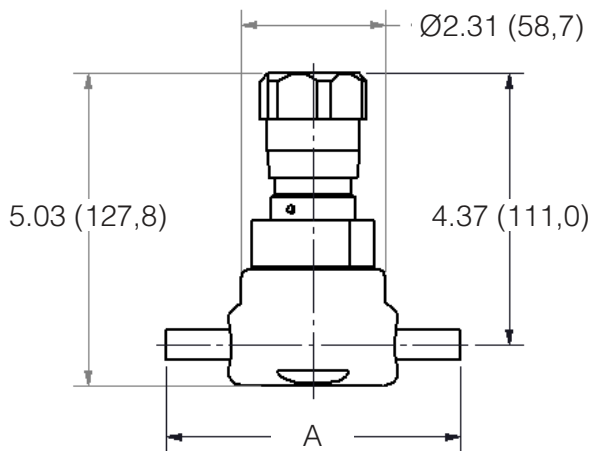

• JSRLF Series with Tube Ends, Inches

VALVE SIZE	A	WEIGHT, LBS
1/2"	3.81	4.2
3/4"	3.81	4.2

• JSRLF Series with Tube Ends, Metric

VALVE SIZE	A	WEIGHT, KG
DN15	96,8	1,9
DN20	96,8	1,9

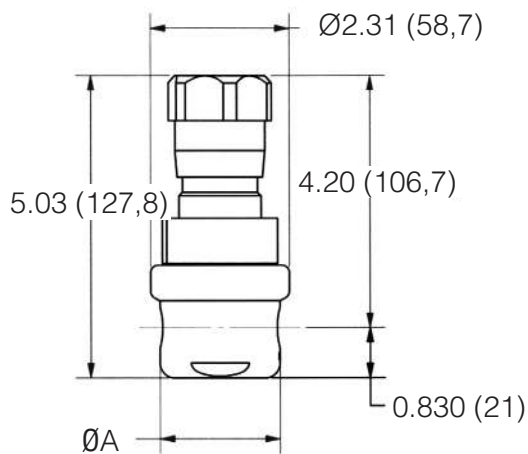

• JSRLF Series with FNPT/SW Ends, Inches

VALVE SIZE	A	WEIGHT, LBS
1/4"	2.00	3.4
3/8"	2.00	3.4
1/2"	2.75	4.2

• JSRLF Series with FNPT/SW Ends, Metric

VALVE SIZE	A	WEIGHT, KG
DN8	50,8	1,5
DN10	50,8	1,5
DN15	69,9	1,9

Cv TRIM SELECTION INSTRUCTIONS

To select a valve with the proper Cv:

1. Select a graph on the following 24 pages that best represents your outlet pressure set point and flow range
2. Looking at that graph, select the closest inlet pressure line (horizontal sloped line, P1) that best reflects your application's actual inlet pressure. That line indicates the Pressure/Flow capabilities and offset (droop) of the trim (Flow Coefficient, Cv) under flowing conditions.
Note: If your exact outlet pressure set point or inlet pressure is not listed you will have to interpolate.
 - Your particular inlet pressure line will be very similar in length and slope to the line chosen on any particular graph.
 - The same is true for your outlet pressure set point, simply shift the line up or down.
3. The Cv is listed in bold at the upper left of the page of your chosen graph. You will need that for model number selection (See page 31).

GAS CONVERSION FACTORS

The following sizing charts for the JSRLF were derived using Nitrogen as the flow medium at ambient conditions. In order to convert your gas to the equivalent volume of Nitrogen, multiply your application's flow by the appropriate multiplying factor below.

GAS	Specific Gravity	Multiplying Factor
Air	1	1.02
Ammonia	0.596	0.79
Argon	1.379	1.19
Arsine	2.695	1.67
CO	0.967	1
CO2	1.529	1.26
Ethylene	0.975	1

GAS	Specific Gravity	Multiplying Factor
Helium	0.138	0.38
Hydrogen	0.07	0.27
Methane	0.555	0.76
Natural Gas	0.555	0.76
Nitrogen	0.967	1
Oxygen	1.105	1.07
Propane	0.495	0.72

For all other gaseous media, use the following formula to calculate the appropriate multiplying factor.

(Sg = Specific Gravity of the media)

$$\frac{1}{\sqrt{\frac{0.967}{Sg(\text{any gas})}}}$$

FLOW DATA FOR Cv TRIM SELECTION

The graphs illustrate the change or "droop" in outlet pressures as the flow rate increases, and the lockup (setpoint rise) as flow decreases and approaches zero.

Flow Coefficient: 0.012

Pressure Control Range

Range Spring: 5-50 psig (0,34 - 3,44 bar)

Set Point: 5 psig (0,34 bar)

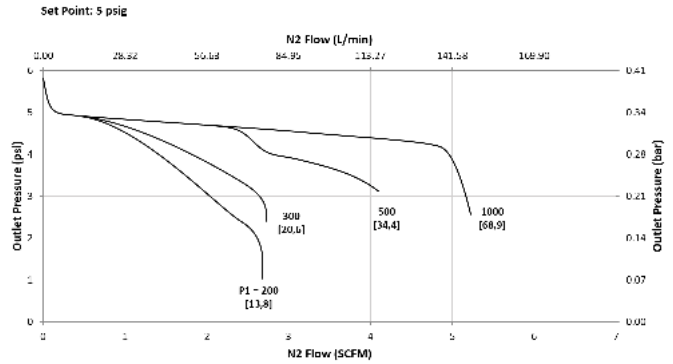
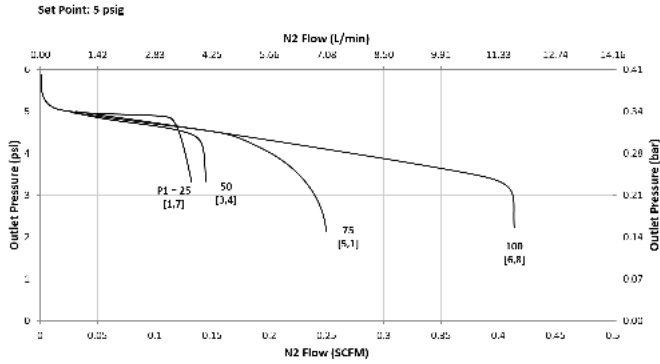

Pressure Control Range

Range Spring: 5-50 psig (0,34 - 3,44 bar)

Set Point: 10 psig (0,69 bar)

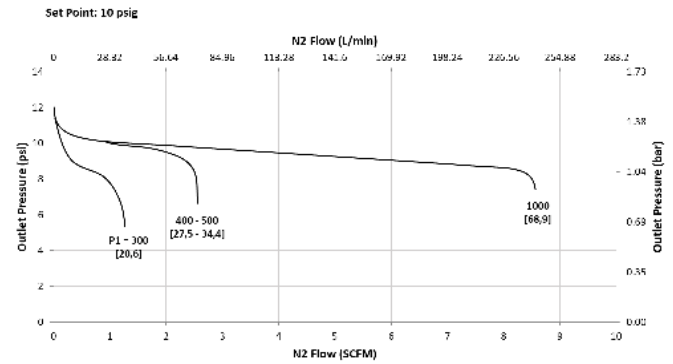
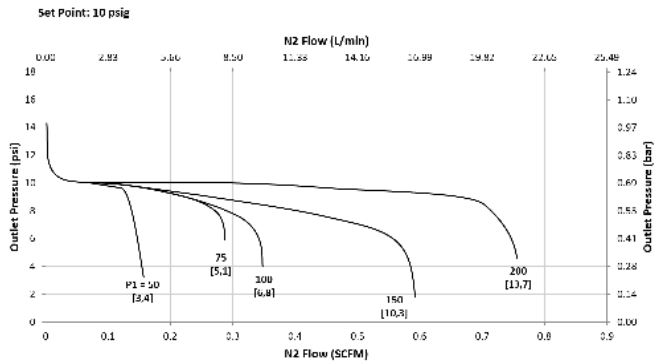

FLOW DATA FOR Cv TRIM SELECTION

The graphs illustrate the change or "droop" in outlet pressures as the flow rate increases, and the lockup (setpoint rise) as flow decreases and approaches zero.

Flow Coefficient: 0.012

Pressure Control Range

Range Spring: 5-50 psig (0,34 - 3,44 bar)

Set Point: 25 psig (1,72 bar)

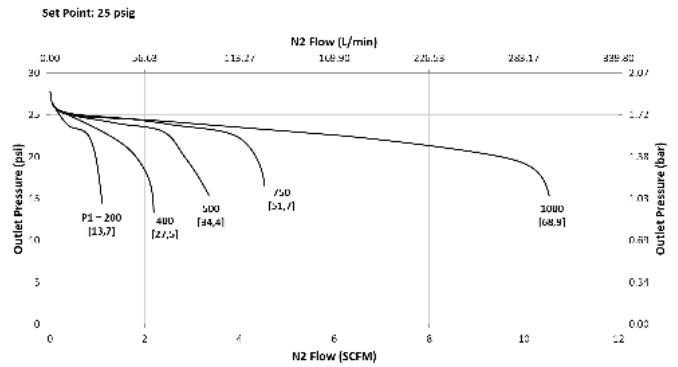
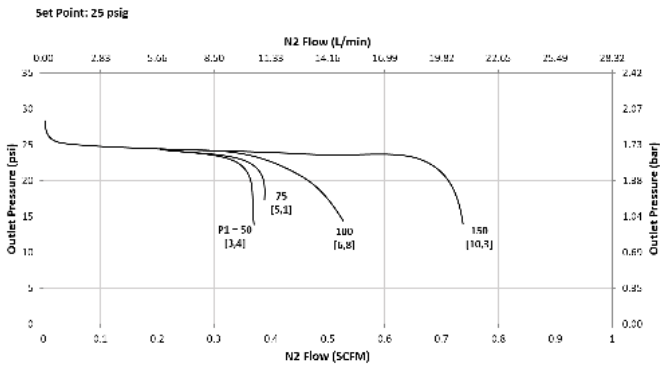

Pressure Control Range

Range Spring: 5-50 psig (0,34 - 3,44 bar)

Set Point: 50 psig (3,44 bar)

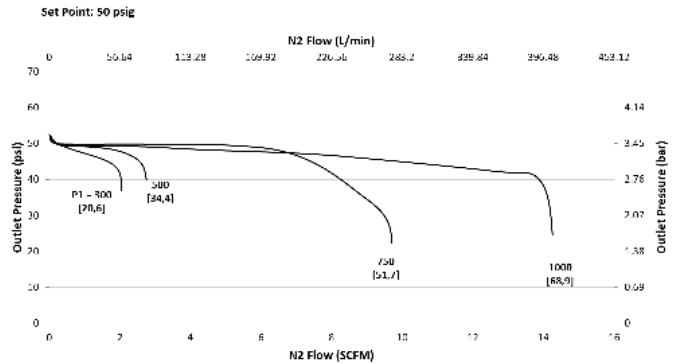
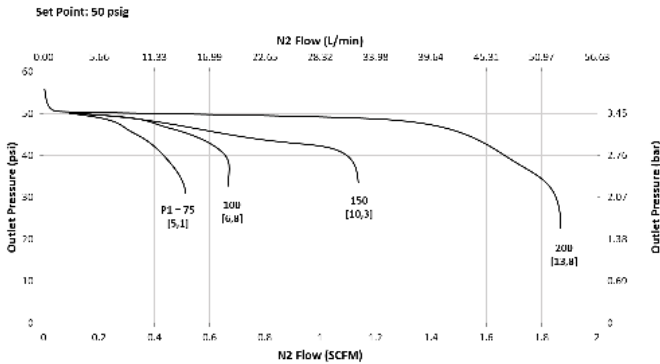

Pressure Control Range

Range Spring: 25 - 100 psig (1,72 - 6,89 bar)

Set Point: 25 psig (1,72 bar)

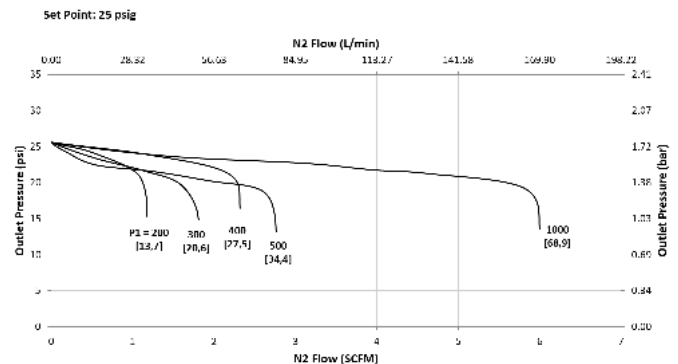
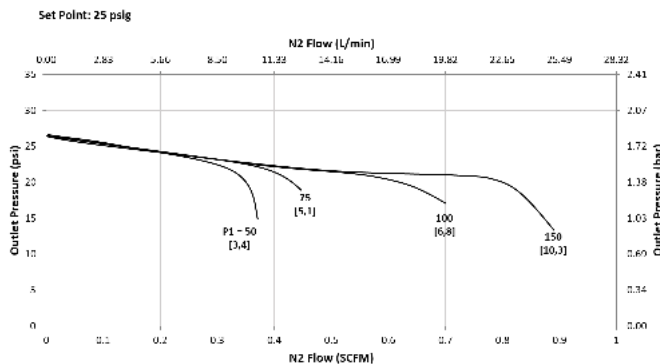

FLOW DATA FOR CV TRIM SELECTION

The graphs illustrate the change or "droop" in outlet pressures as the flow rate increases, and the lockup (setpoint rise) as flow decreases and approaches zero.

Flow Coefficient: 0.012

Pressure Control Range

Range Spring: 25 - 100 psig (1,72 - 6,89 bar)

Set Point: 50 psig (3,44 bar)

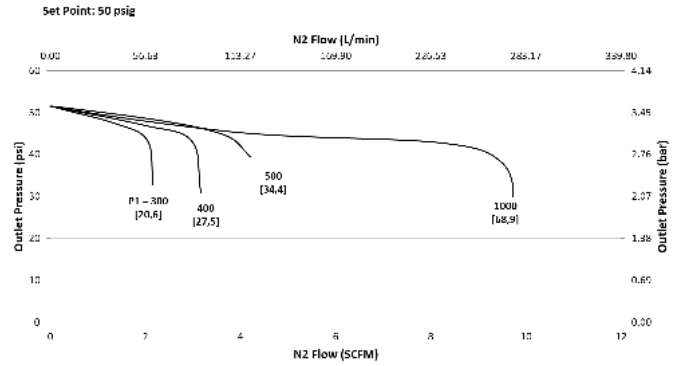
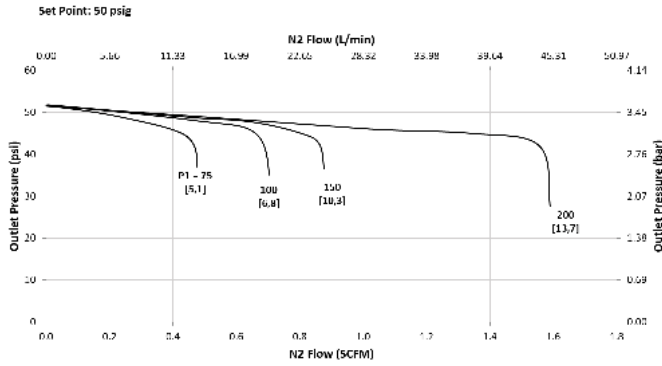

Pressure Control Range

Range Spring: 25 - 100 psig (1,72 - 6,89 bar)

Set Point: 75 psig (5,17 bar)

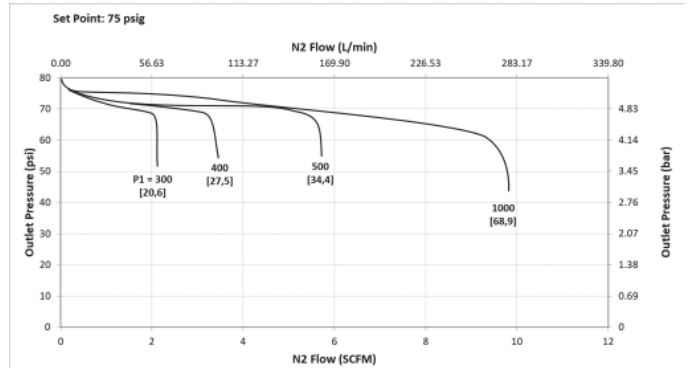
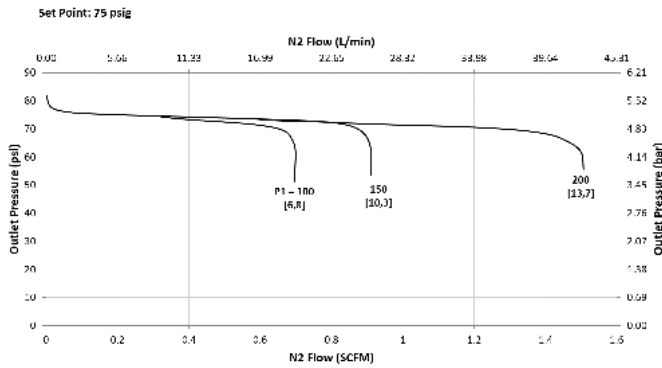

Pressure Control Range

Range Spring: 25 - 100 psig (1,72 - 6,89 bar)

Set Point: 100 psig (6,89 bar)

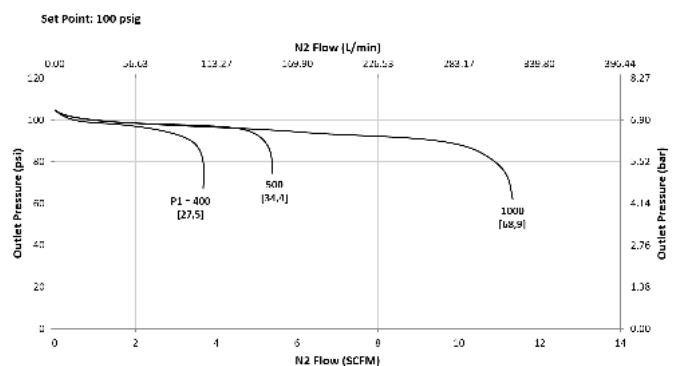
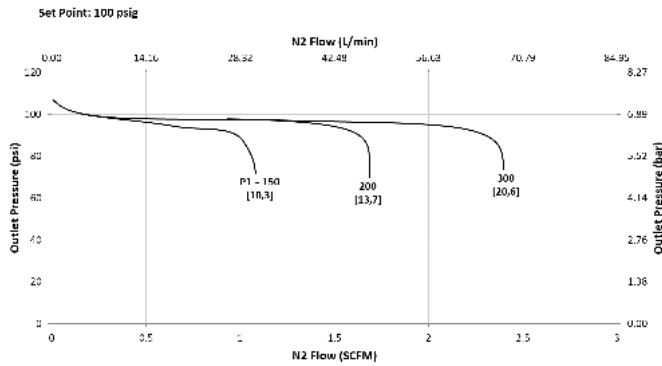

FLOW DATA FOR Cv TRIM SELECTION

The graphs illustrate the change or "droop" in outlet pressures as the flow rate increases, and the lockup (setpoint rise) as flow decreases and approaches zero.

Flow Coefficient: 0.012

Pressure Control Range

Range Spring: 50 - 150 psig (3,44 - 10,34 bar)

Set Point: 50 psig (3,44 bar)

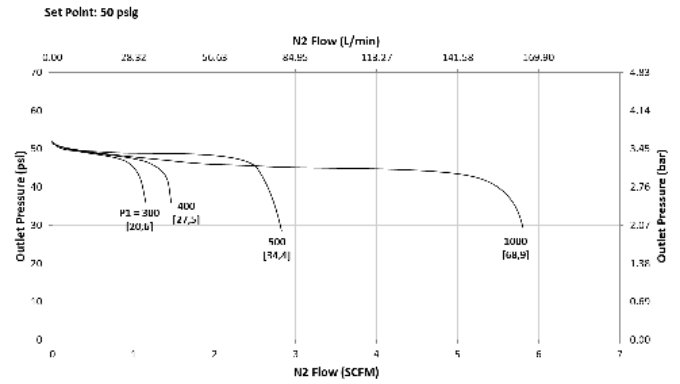
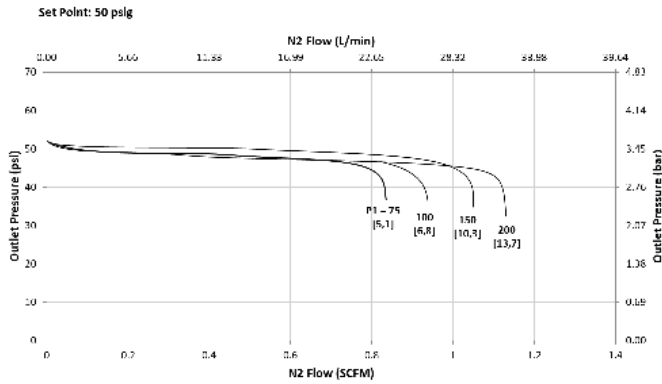

Pressure Control Range

Range Spring: 50 - 150 psig (3,44 - 10,34 bar)

Set Point: 75 psig (5,17 bar)

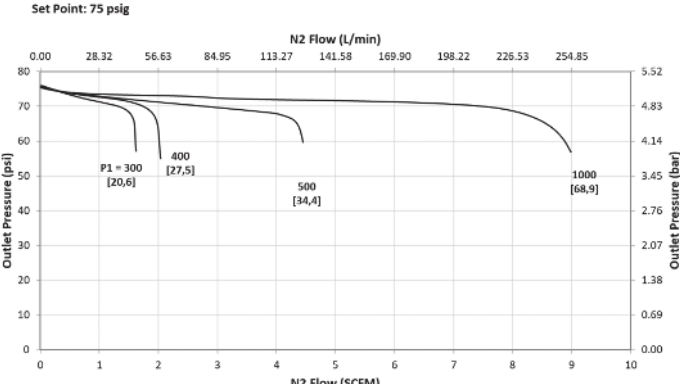
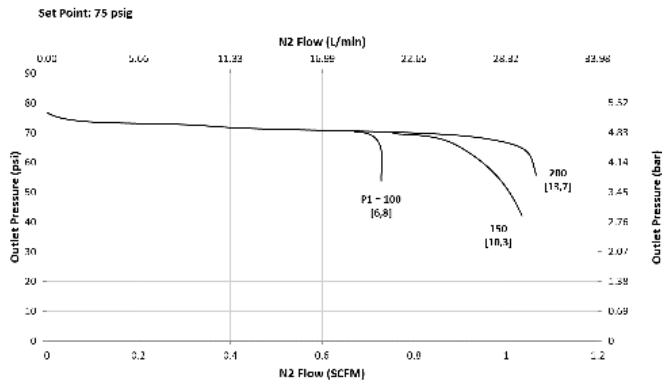

Pressure Control Range

Range Spring: 50 - 150 psig (3,44 - 10,34 bar)

Set Point: 100 psig (6,89 bar)

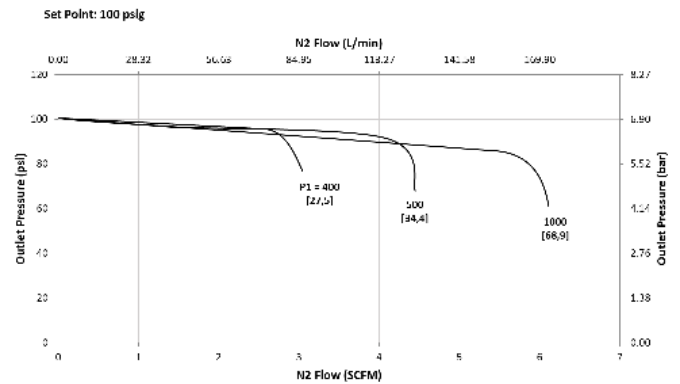
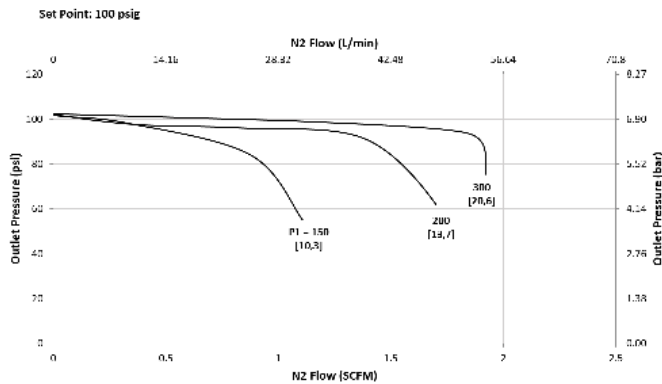

FLOW DATA FOR Cv TRIM SELECTION

The graphs illustrate the change or "droop" in outlet pressures as the flow rate increases, and the lockup (setpoint rise) as flow decreases and approaches zero.

Flow Coefficient: 0.012

Pressure Control Range

Range Spring: 50 - 150 psig (3,44 - 10,34 bar)

Set Point: 150 psig (10,34 bar)

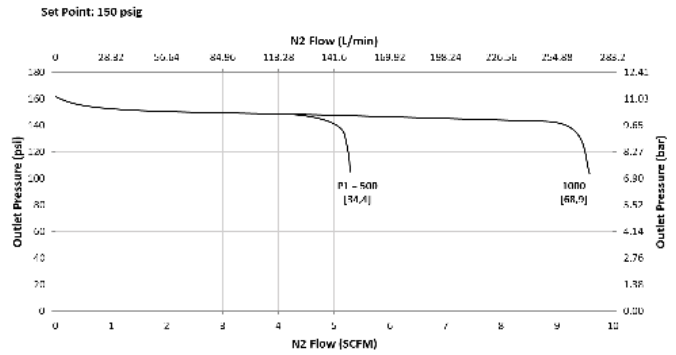
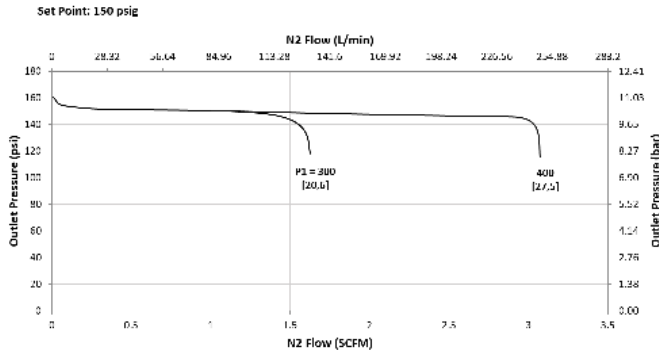

Pressure Control Range

Range Spring: 75 - 250 psig (5,17 - 17,23 bar)

Set Point: 75 psig (5,17 bar)

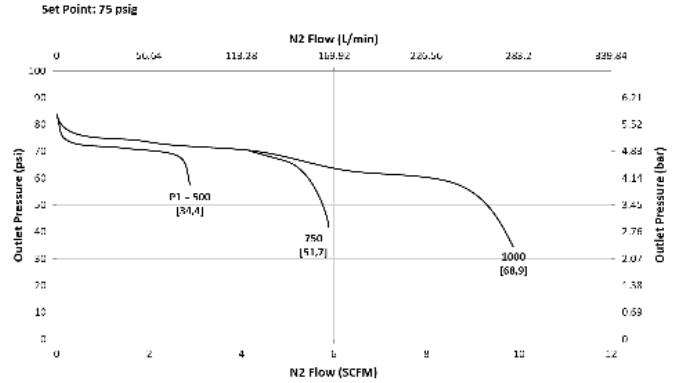
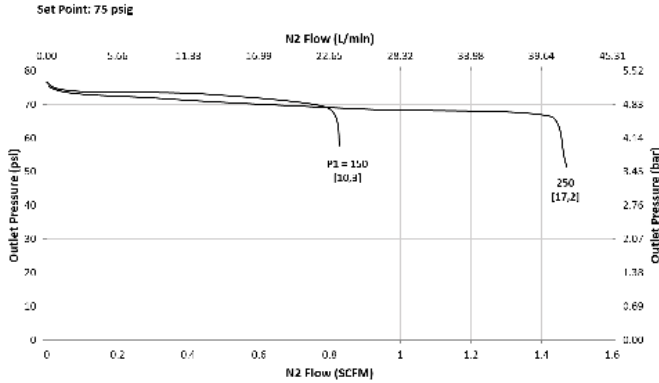

Pressure Control Range

Range Spring: 75 - 250 psig (5,17 - 17,23 bar)

Set Point: 150 psig (10,34 bar)

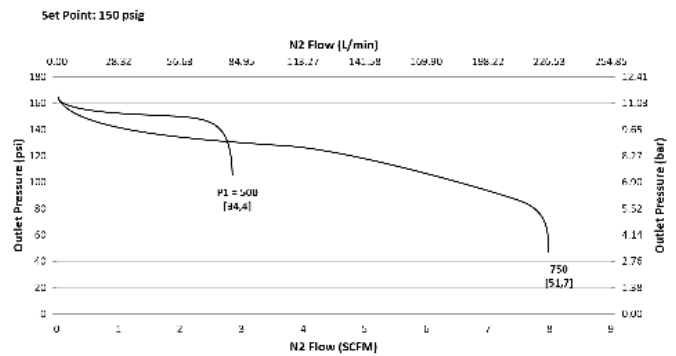
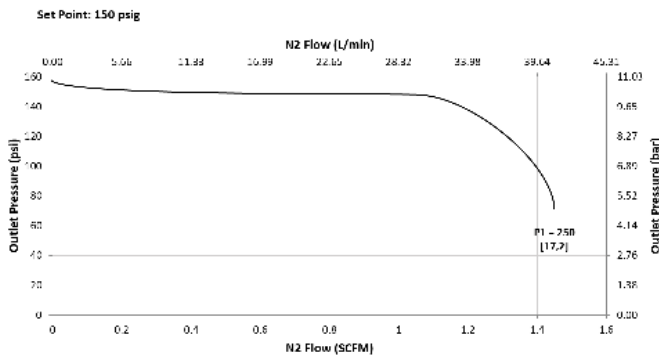

FLOW DATA FOR Cv TRIM SELECTION

The graphs illustrate the change or "droop" in outlet pressures as the flow rate increases, and the lockup (setpoint rise) as flow decreases and approaches zero.

Flow Coefficient: 0.012

Pressure Control Range

Range Spring: 75 - 250 psig (5,17 - 17,23 bar)

Set Point: 200 psig (13,48 bar)

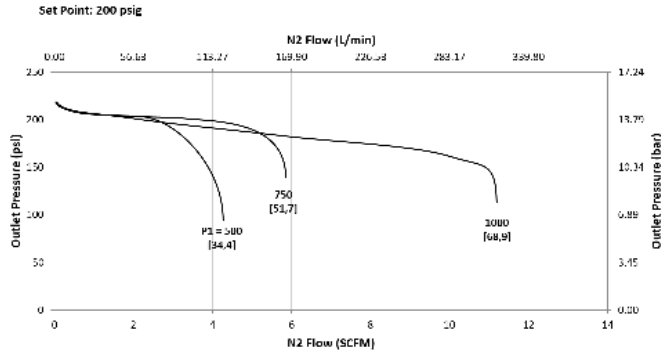

Pressure Control Range

Range Spring: 75 - 250 psig (5,17 - 17,23 bar)

Set Point: 250 psig (17,23 bar)

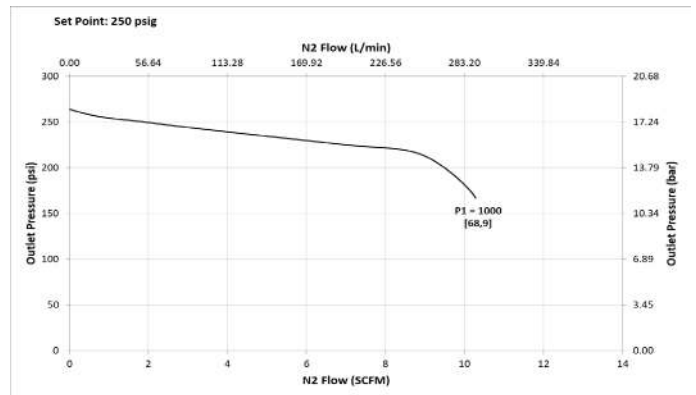
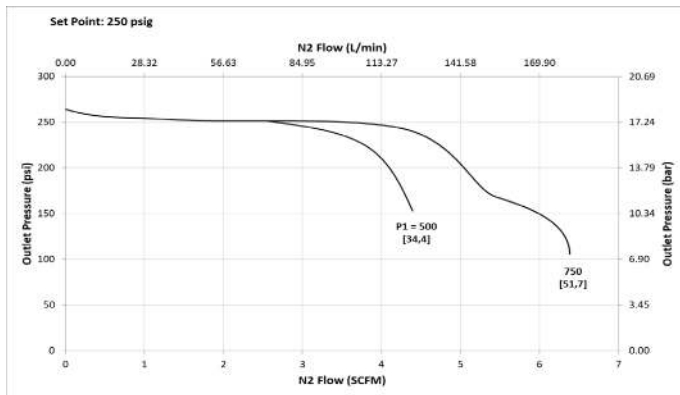

Pressure Control Range

Range Spring: 100 - 475 psig (6,89 - 32,75 bar)

Set Point: 100 psig (6,89 bar)

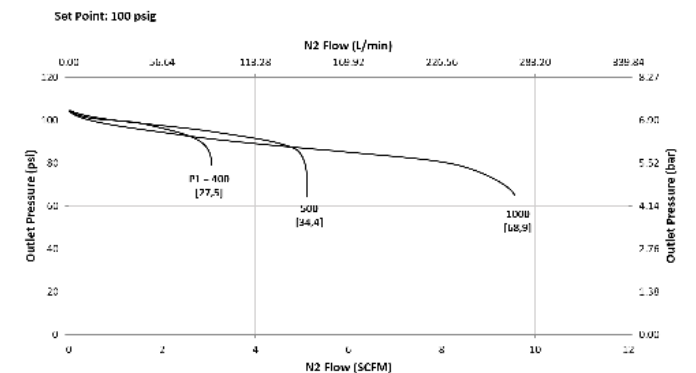
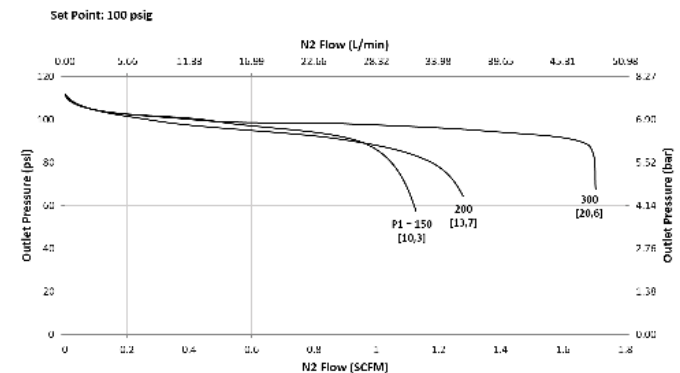

FLOW DATA FOR Cv TRIM SELECTION

The graphs illustrate the change or "droop" in outlet pressures as the flow rate increases, and the lockup (setpoint rise) as flow decreases and approaches zero.

Flow Coefficient: 0.012

Pressure Control Range

Range Spring: 100 - 475 psig (6,89 – 32,75 bar)

Set Point: 150 psig (10,34 bar)

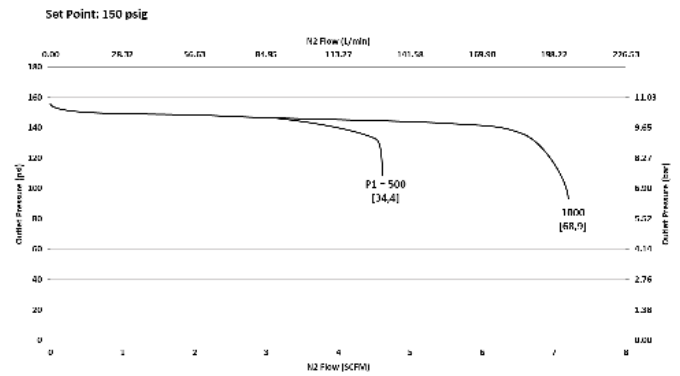
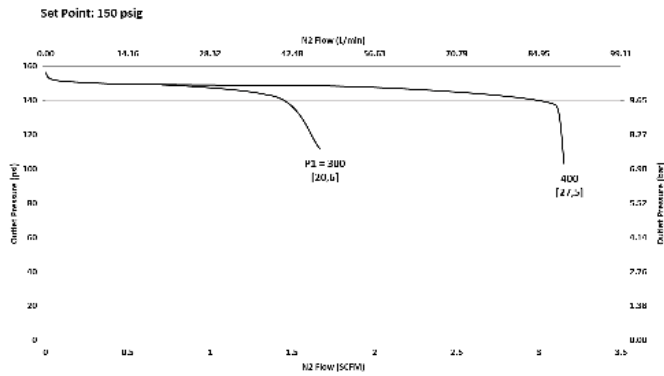

Pressure Control Range

Range Spring: 100 - 475 psig (6,89 – 32,75 bar)

Set Point: 200 and 250 psig (13,78 and 17,23 bar)

Pressure Control Range

Range Spring: 200 - 750 psig (13,78 – 51,71 bar)

Set Point: 200/250/500/750 psig (13,78/17,23/34,47/51,71 bar)

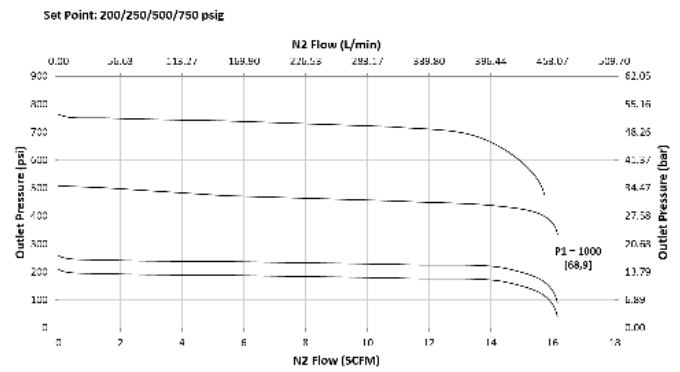
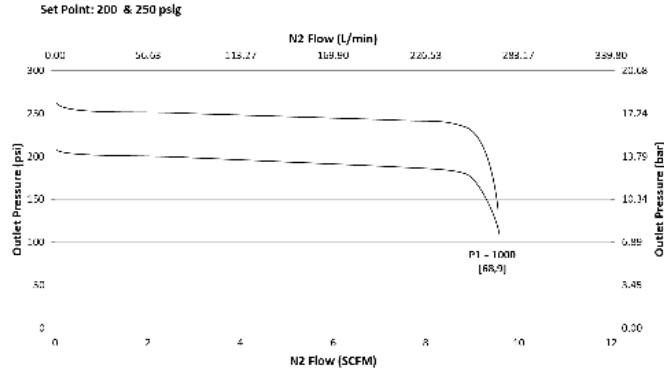

Flow Coefficient: 0.03

Pressure Control Range

Range Spring: 5 - 50 psig (0,34 - 3,44 bar)

Set Point: 5 psig (0,34 bar)

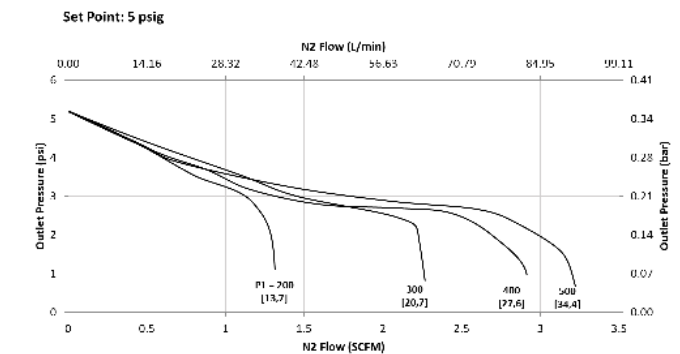
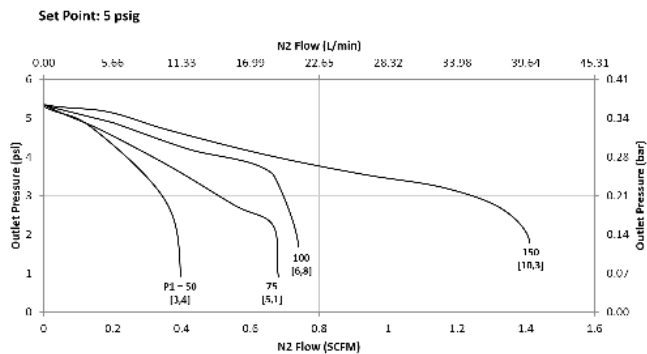

FLOW DATA FOR Cv TRIM SELECTION

The graphs illustrate the change or "droop" in outlet pressures as the flow rate increases, and the lockup (setpoint rise) as flow decreases and approaches zero.

Flow Coefficient: 0.03

Pressure Control Range

Range Spring: 5-50 psig (0,34 - 3,44 bar)

Set Point: 5 psig (0,34 bar)

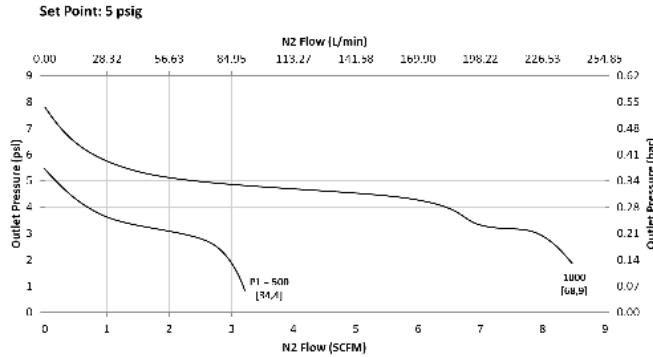

Pressure Control Range

Range Spring: 5-50 psig (0,34 - 3,44 bar)

Set Point: 10 psig (0,69 bar)

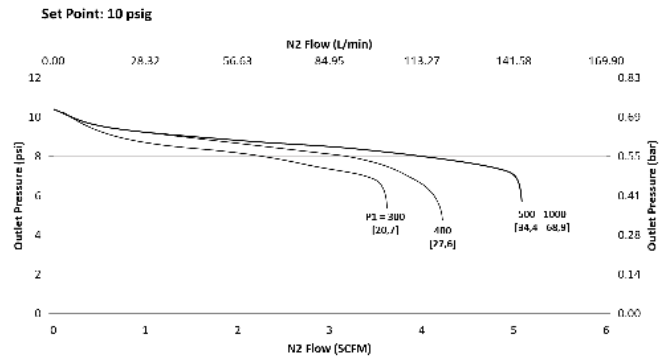
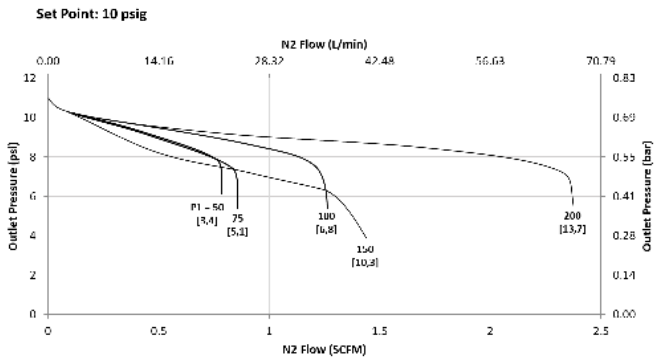

Pressure Control Range

Range Spring: 5 - 50 psig (0,34 - 3,44 bar)

Set Point: 25 psig (1,72 bar)

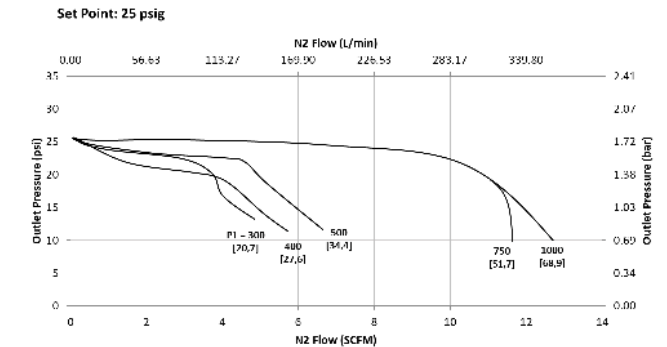
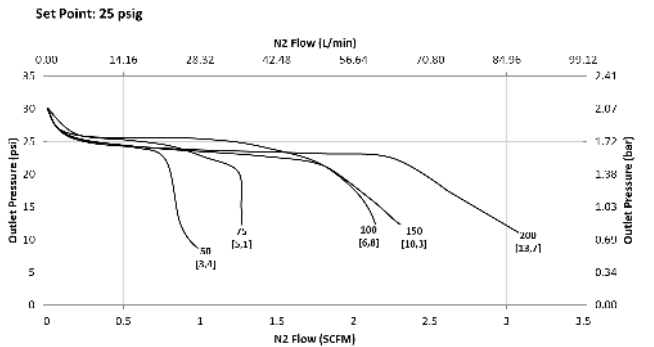

FLOW DATA FOR Cv TRIM SELECTION

The graphs illustrate the change or "droop" in outlet pressures as the flow rate increases, and the lockup (setpoint rise) as flow decreases and approaches zero.

Flow Coefficient: 0.03

Pressure Control Range

Range Spring: 5-50 psig (0,34 - 3,44 bar)

Set Point: 50 psig (3,44 bar)

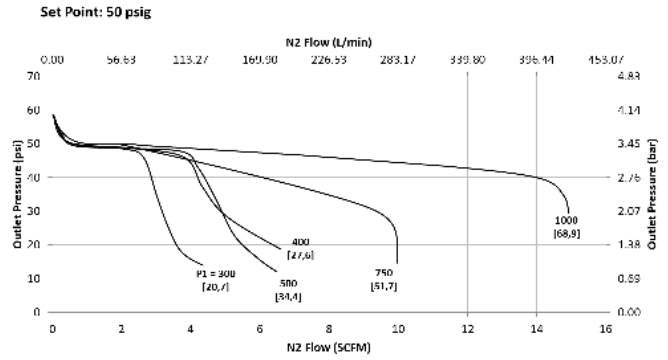
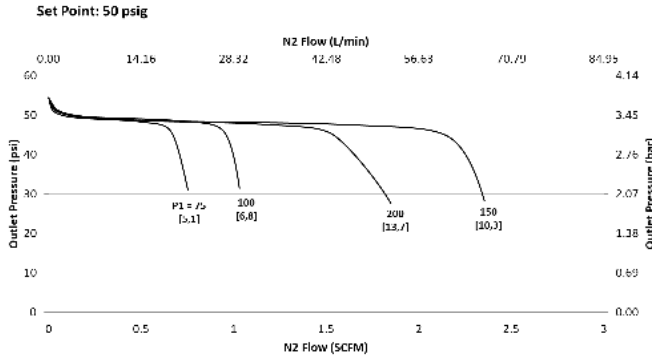

Pressure Control Range

Range Spring: 25 - 100 psig (1,72 - 6,89 bar)

Set Point: 25 psig (1,72 bar)

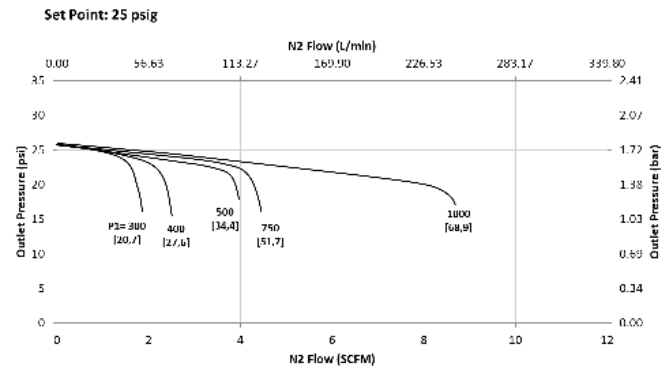
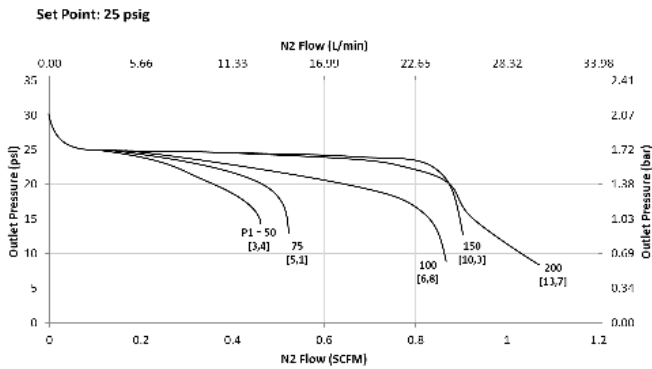

Pressure Control Range

Range Spring: 25 - 100 psig (1,72 - 6,89 bar)

Set Point: 50 psig (3,44 bar)

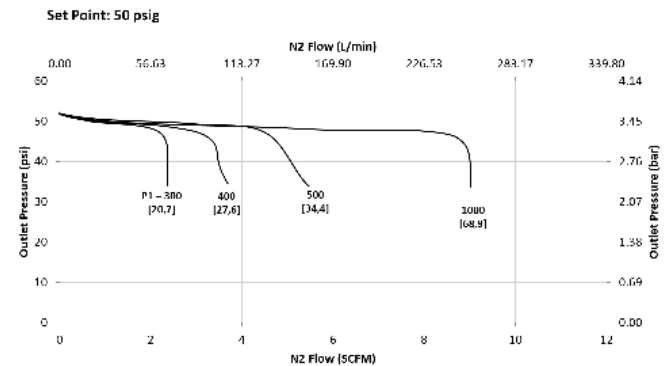
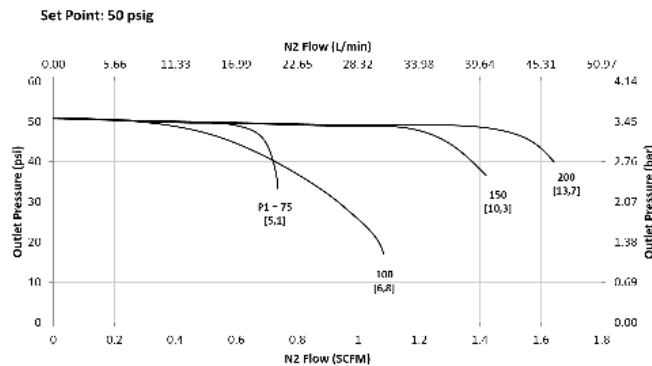

FLOW DATA FOR Cv TRIM SELECTION

The graphs illustrate the change or "droop" in outlet pressures as the flow rate increases, and the lockup (setpoint rise) as flow decreases and approaches zero.

Flow Coefficient: 0.03

Pressure Control Range

Range Spring: 25 - 100 psig (1,72 - 6,89 bar)

Set Point: 75 psig (5,17 bar)

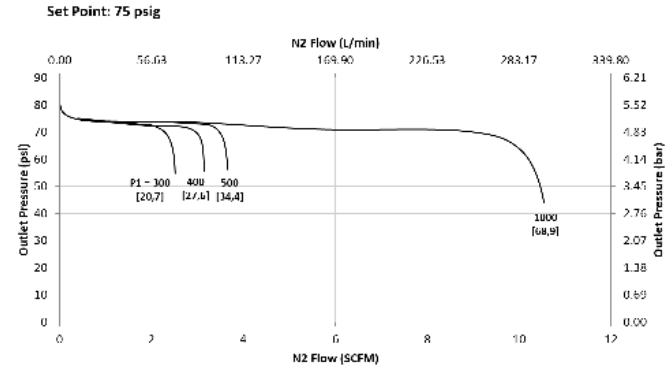
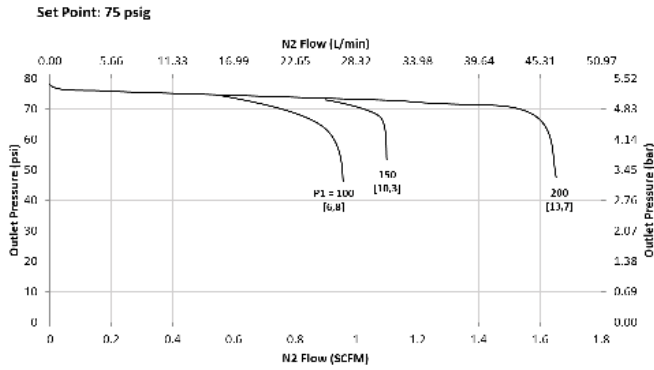

Pressure Control Range

Range Spring: 25 - 100 psig (1,72 - 6,89 bar)

Set Point: 100 psig (6,89 bar)

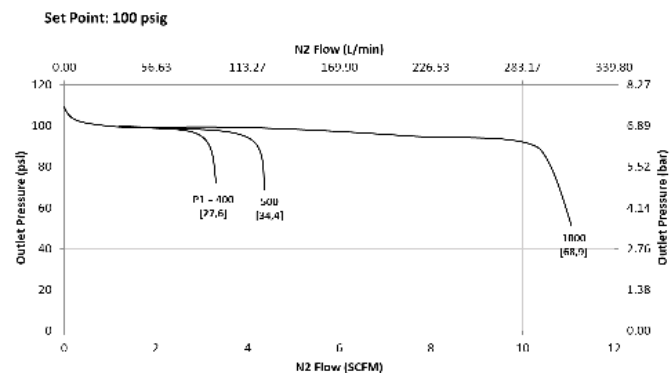
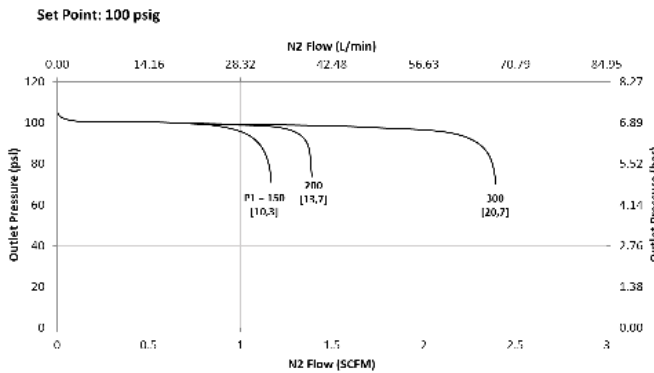

Pressure Control Range

Range Spring: 50 - 150 psig (3,44 - 10,34 bar)

Set Point: 50 psig (3,44 bar)

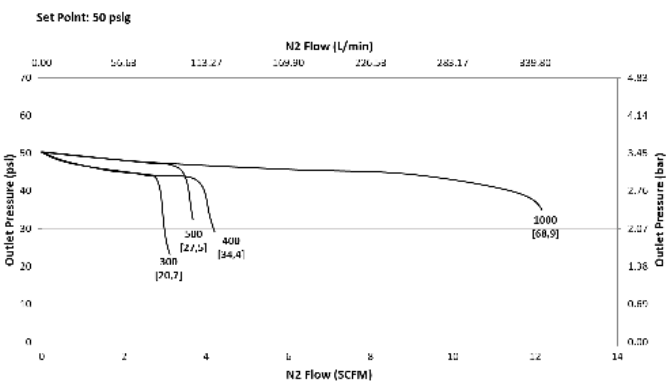
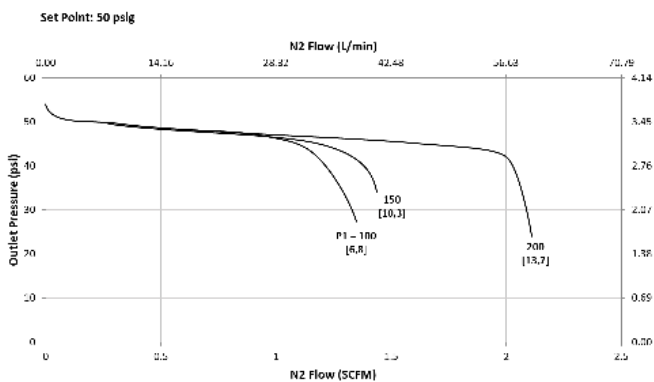

FLOW DATA FOR CV TRIM SELECTION

The graphs illustrate the change or "droop" in outlet pressures as the flow rate increases, and the lockup (setpoint rise) as flow decreases and approaches zero.

Flow Coefficient: 0.03

Pressure Control Range

Range Spring: 50 - 150 psig (3,44 - 10,34 bar)

Set Point: 75 psig (5,17 bar)

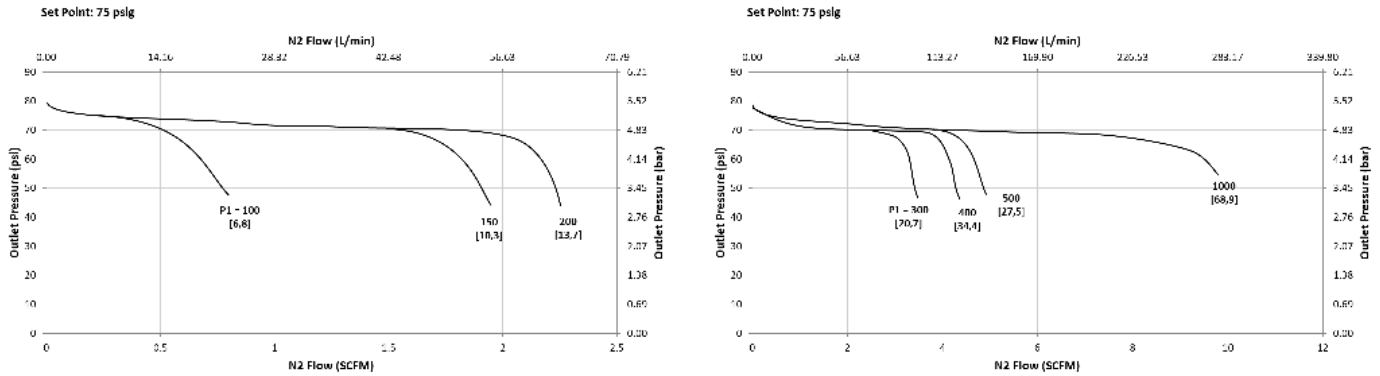

Pressure Control Range

Range Spring: 50 - 150 psig (3,44 - 10,34 bar)

Set Point: 100 psig (6,89 bar)

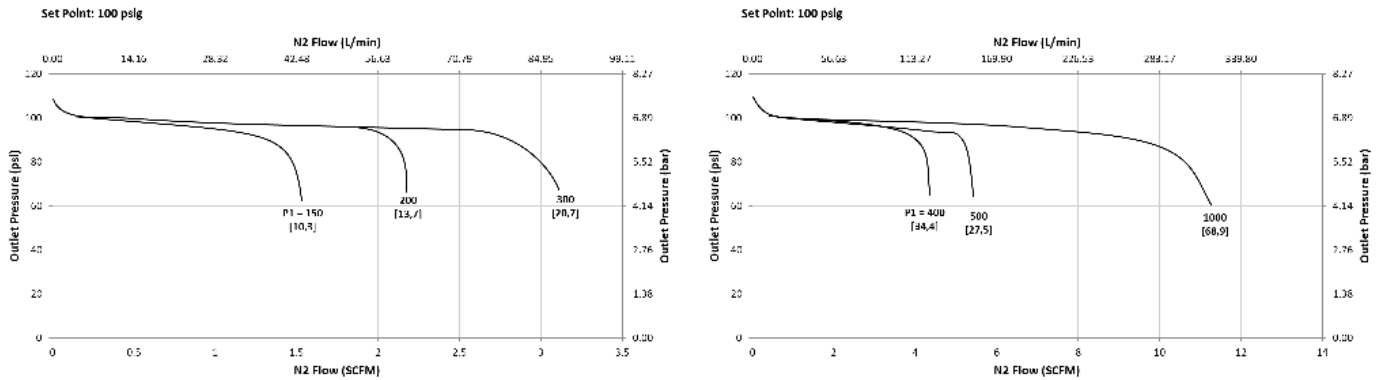

Pressure Control Range

Range Spring: 50 - 150 psig (3,44 - 10,34 bar)

Set Point: 150 psig (10,34 bar)

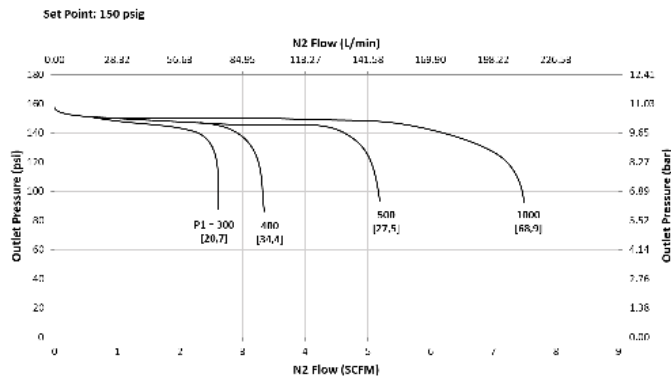

FLOW DATA FOR Cv TRIM SELECTION

The graphs illustrate the change or "droop" in outlet pressures as the flow rate increases, and the lockup (setpoint rise) as flow decreases and approaches zero.

Flow Coefficient: 0.03

Pressure Control Range

Range Spring: 75 - 250 psig (5,17 – 17,23 bar)

Set Point: 75/100 psig (5,17/6,89 bar)

Pressure Control Range

Range Spring: 75 - 250 psig (5,17 – 17,23 bar)

Set Point: 150/200/250 psig (10,34/13,78/17,23 bar)

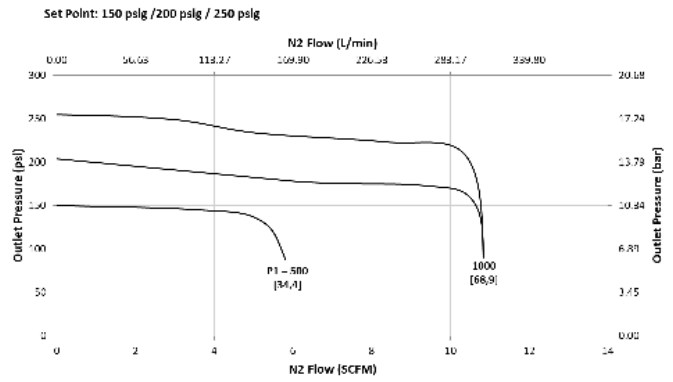
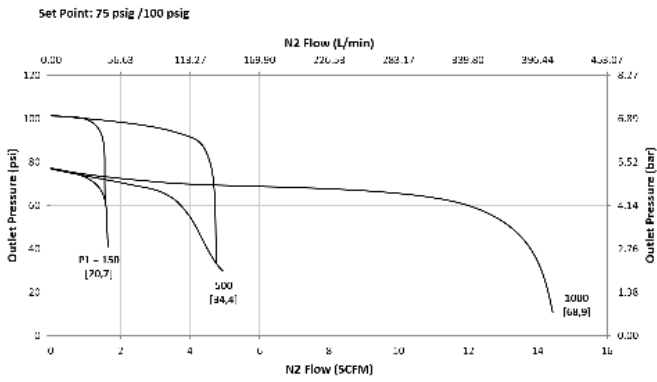

Pressure Control Range

Range Spring: 100 - 475 psig (6,89 – 32,75 bar)

Set Point: 100 psig (6,89 bar)

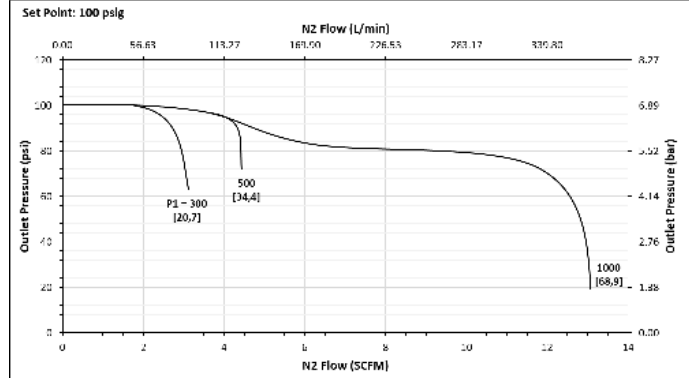
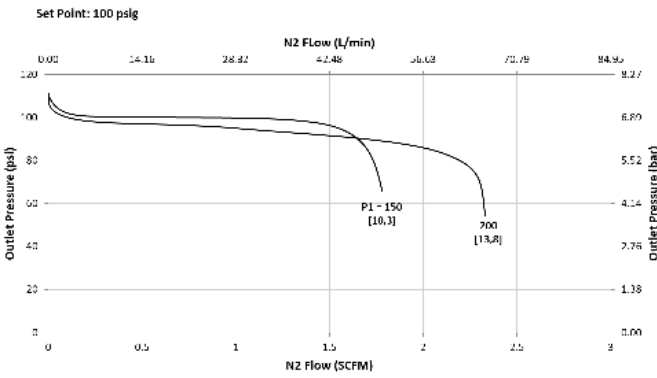

Pressure Control Range

Range Spring: 100 - 475 psig (6,89 – 32,75 bar)

Set Point: 150 psig (10,34 bar)

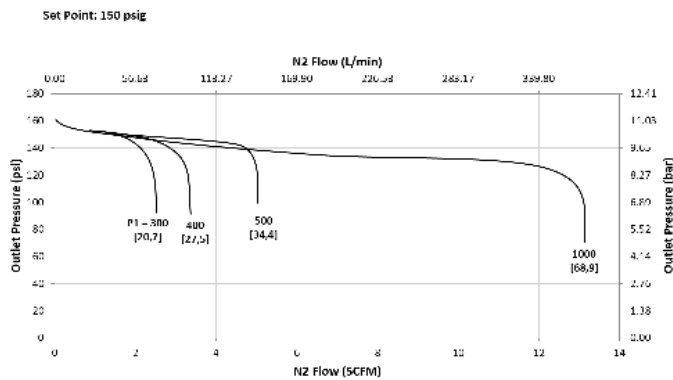

FLOW DATA FOR Cv TRIM SELECTION

The graphs illustrate the change or "droop" in outlet pressures as the flow rate increases, and the lockup (setpoint rise) as flow decreases and approaches zero.

Flow Coefficient: 0.03

Pressure Control Range

Range Spring: 100 - 475 psig (6,89 – 32,75 bar)

Set Point: 200/250 psig (13,78/17,23 bar)

Pressure Control Range

Range Spring: 200 - 750 psig (13,78 – 51,71 bar)

Set Point: 200/250 psig (13,78/17,23 bar)

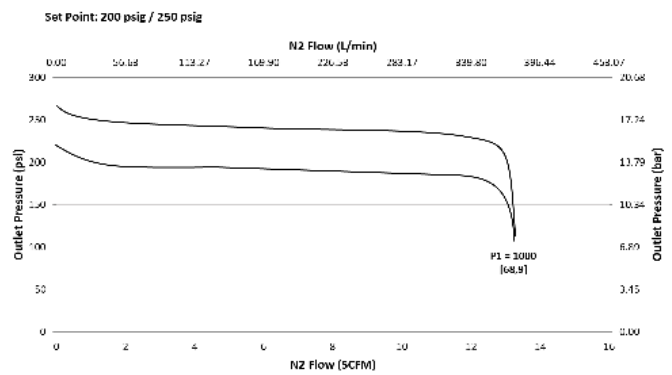
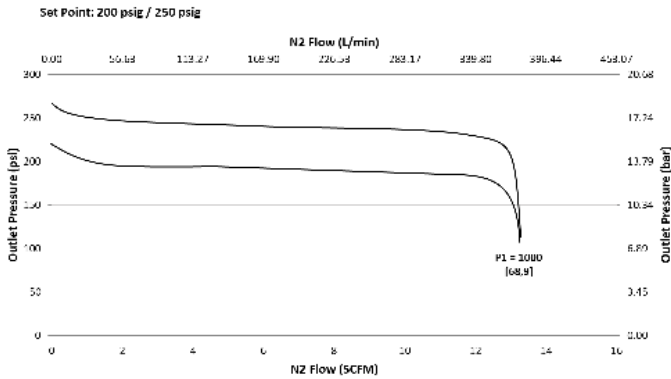

Flow Coefficient: 0.08

Pressure Control Range

Range Spring: 5-50 psig (0,34 - 3,44 bar)

Set Point: 5 psig (0,34 bar)

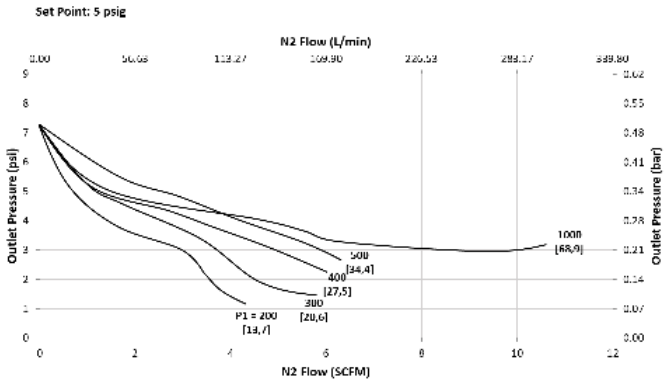
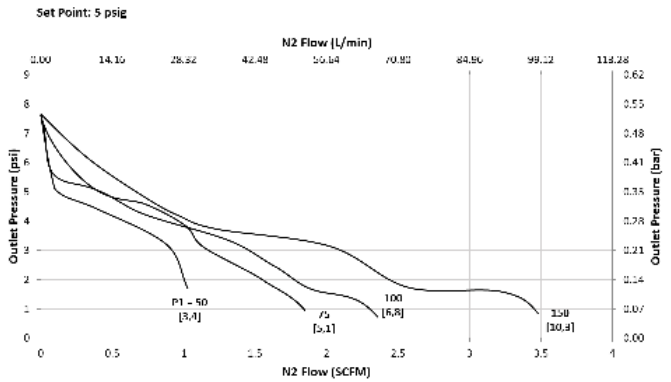

Flow Coefficient: 0.08

Pressure Control Range

Range Spring: 5-50 psig (0,34 - 3,44 bar)

Set Point: 10 psig (0,69 psi)

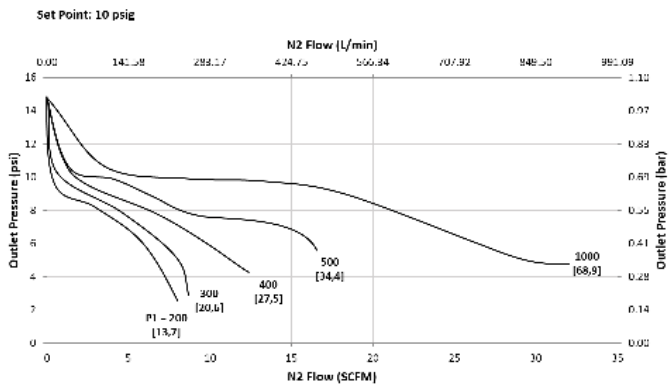
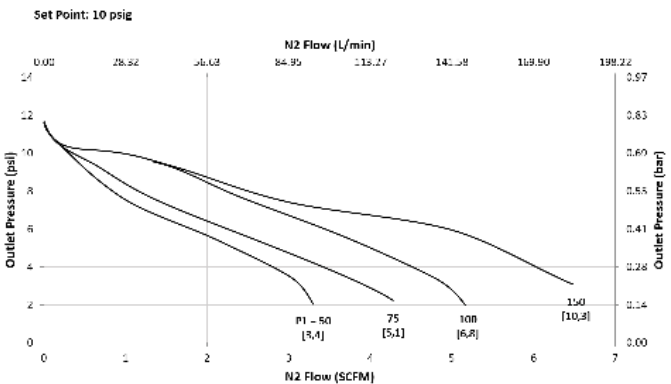

FLOW DATA FOR Cv TRIM SELECTION

The graphs illustrate the change or "droop" in outlet pressures as the flow rate increases, and the lockup (setpoint rise) as flow decreases and approaches zero.

Flow Coefficient: 0.08

Pressure Control Range

Range Spring: 5-50 psig (0,34 - 3,44 bar)

Set Point: 25 psig (1,72 bar)

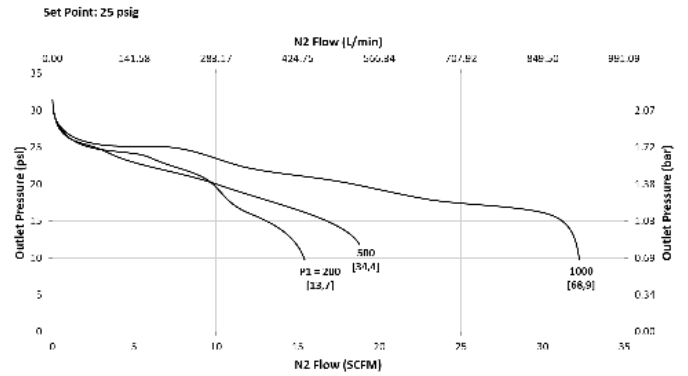
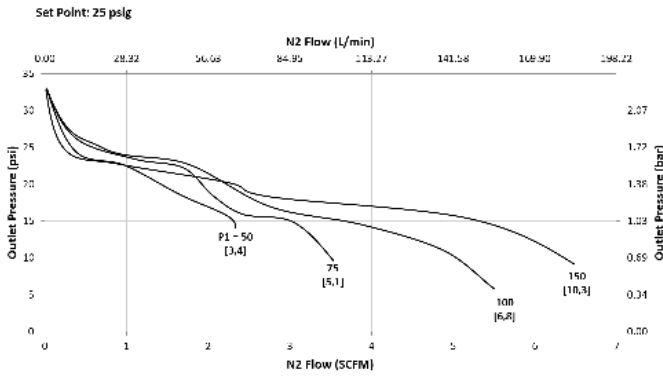

Pressure Control Range

Range Spring: 5-50 psig (0,34 - 3,44 bar)

Set Point: 50 psig (3,44 bar)

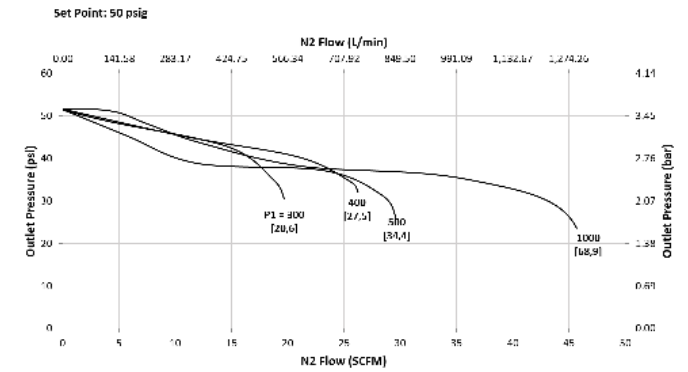
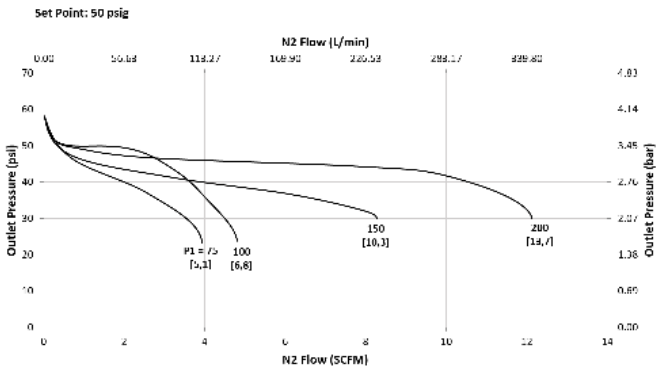

Pressure Control Range

Range Spring: 25 - 100 psig (1,72 - 6,89 bar)

Set Point: 25 psig (1,72 bar)

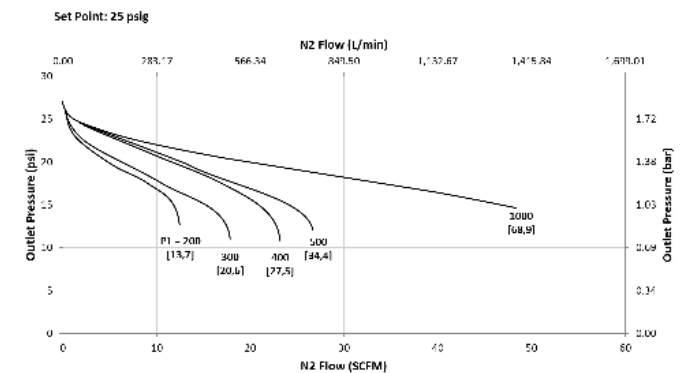
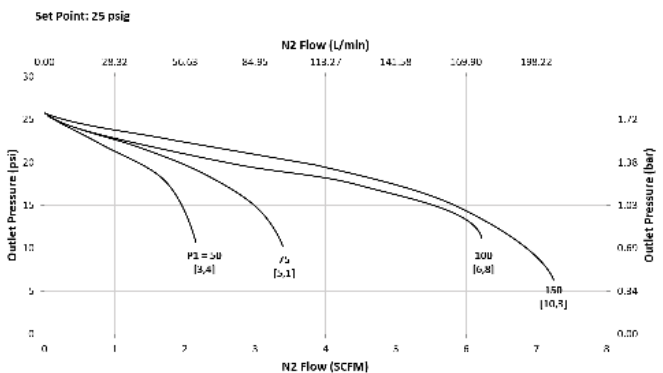

FLOW DATA FOR Cv TRIM SELECTION

The graphs illustrate the change or "droop" in outlet pressures as the flow rate increases, and the lockup (setpoint rise) as flow decreases and approaches zero.

Flow Coefficient: 0.08

Pressure Control Range

Range Spring: 25 - 100 psig (1,72 - 6,89 bar)

Set Point: 50 psig (3,44 bar)

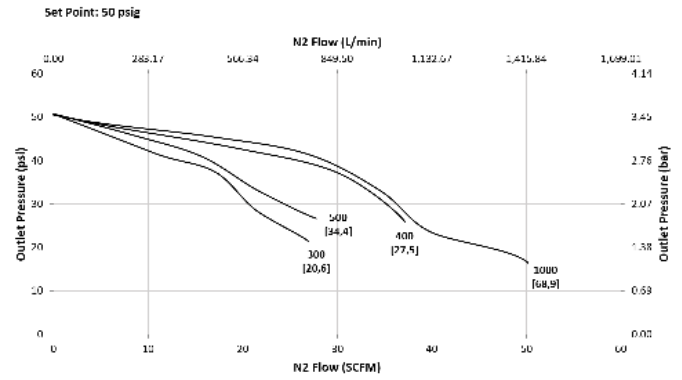
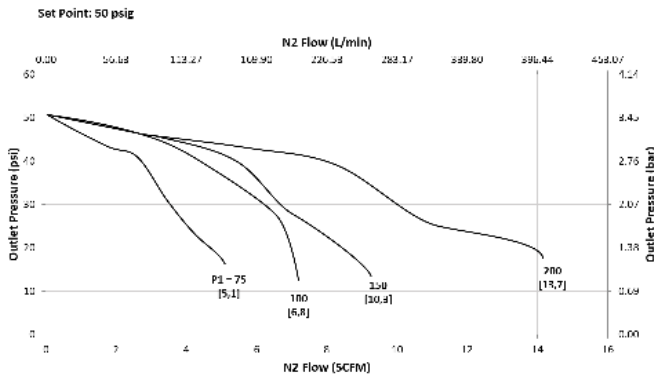

Pressure Control Range

Range Spring: 25 - 100 psig (1,72 - 6,89 bar)

Set Point: 75 psig (5,17 bar)

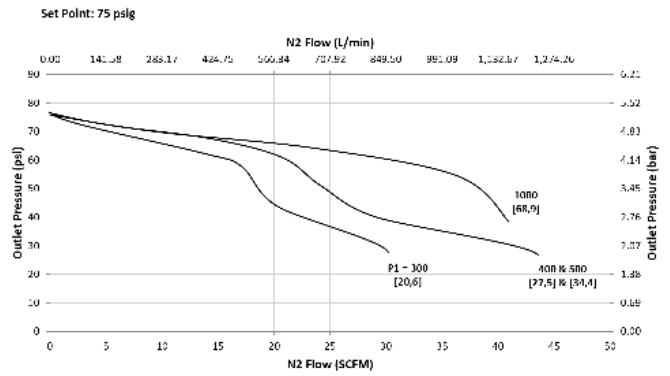
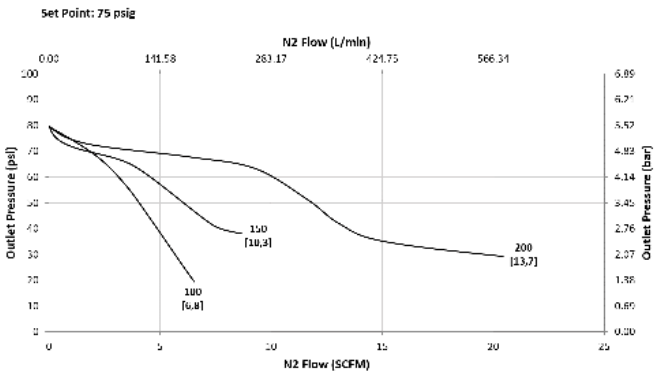

Pressure Control Range

Range Spring: 25 - 100 psig (1,72 - 6,89 bar)

Set Point: 100 psig (6,89 bar)

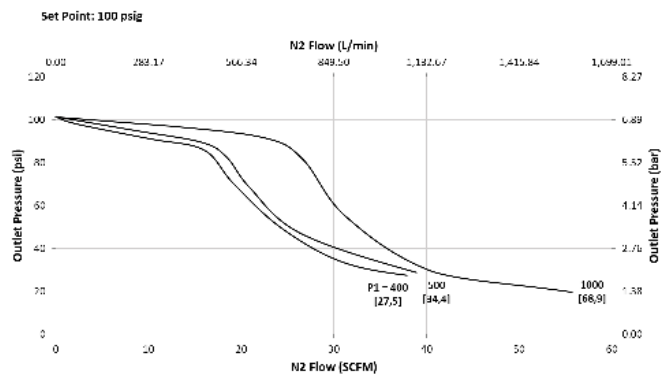
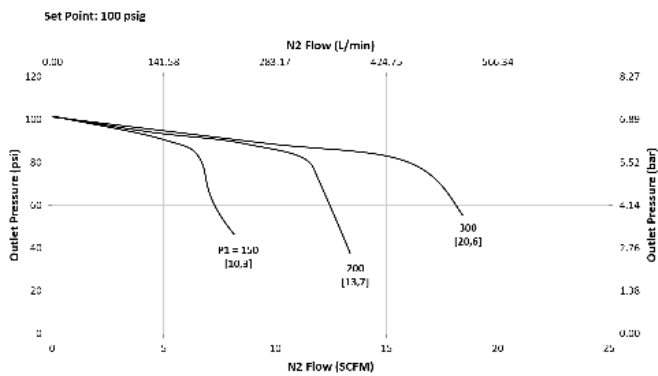

FLOW DATA FOR Cv TRIM SELECTION

The graphs illustrate the change or "droop" in outlet pressures as the flow rate increases, and the lockup (setpoint rise) as flow decreases and approaches zero.

Flow Coefficient: 0.08

Pressure Control Range

Range Spring: 50 - 150 psig (3,44 - 10,34 bar)

Set Point: 50 psig (3,44 bar)

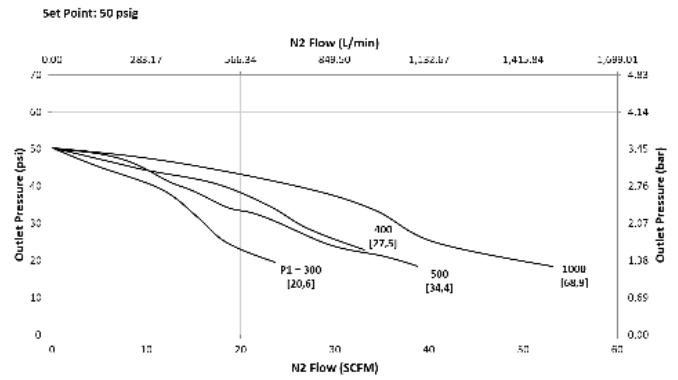
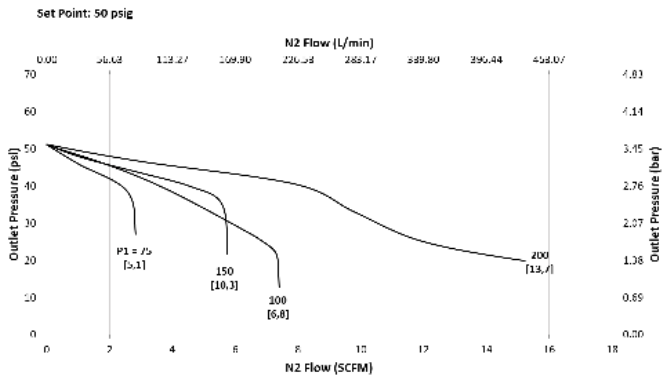

Pressure Control Range

Range Spring: 50 - 150 psig (3,44 - 10,34 bar)

Set Point: 75 psig (5,17 bar)

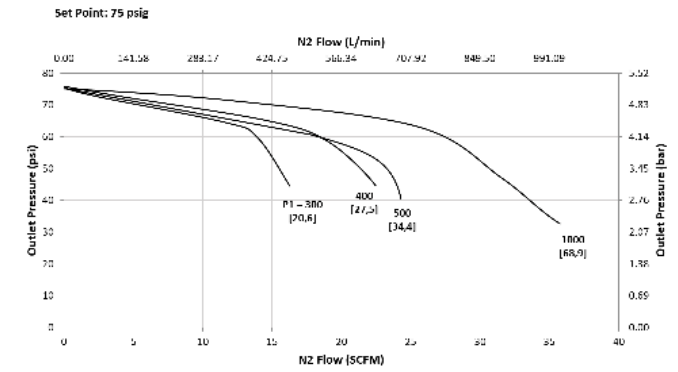
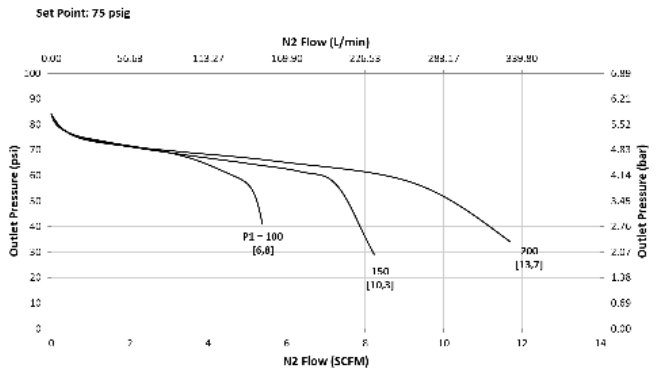

Pressure Control Range

Range Spring: 50 - 150 psig (3,44 - 10,34 bar)

Set Point: 100 psig (6,89 bar)

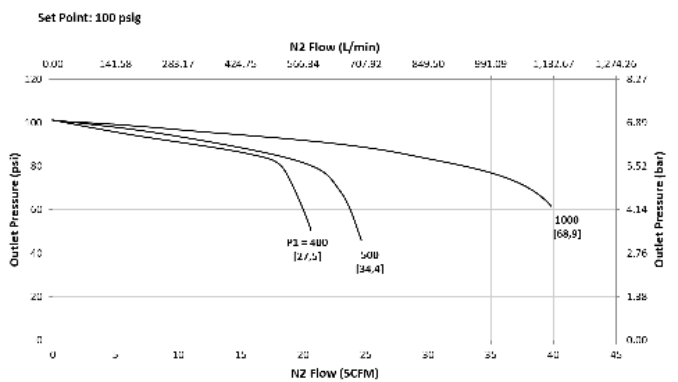
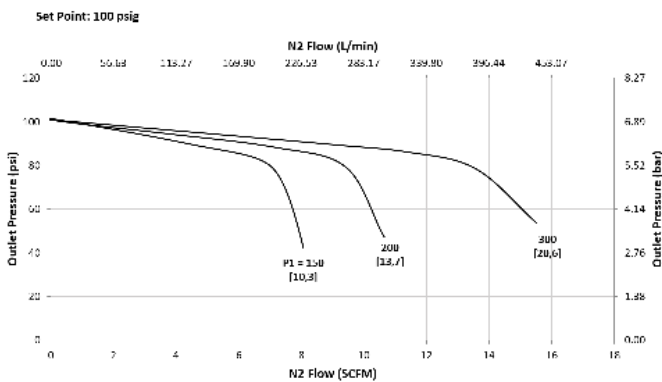

FLOW DATA FOR Cv TRIM SELECTION

The graphs illustrate the change or "droop" in outlet pressures as the flow rate increases, and the lockup (setpoint rise) as flow decreases and approaches zero.

Flow Coefficient: 0.08

Pressure Control Range

Range Spring: 50 - 150 psig (3,44 - 10,34 bar)

Set Point: 150 psig (10,34 bar)

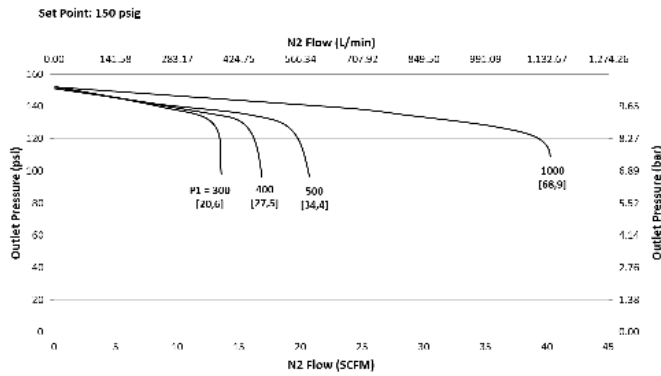

Pressure Control Range

Range Spring: 75 - 250 psig (5,17 - 17,23 bar)

Set Point: 75 psig (5,17 bar)

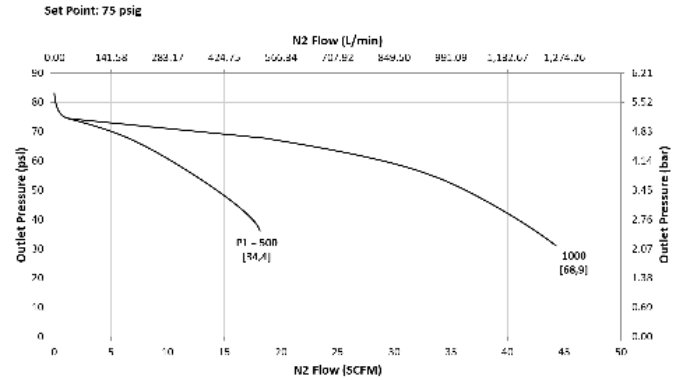
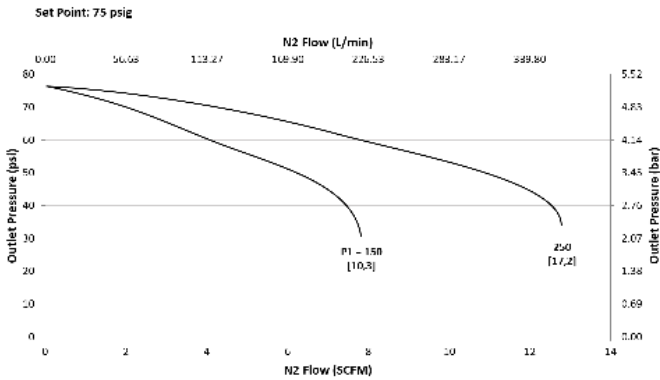

Pressure Control Range

Range Spring: 75 - 250 psig (5,17 - 17,23 bar)

Set Point: 100/150 psig (6,89/10,34 bar)

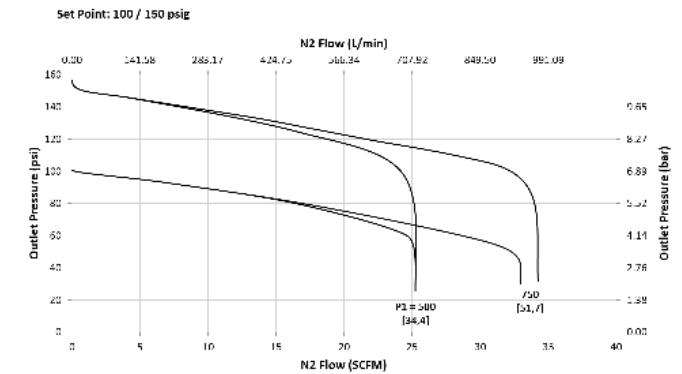
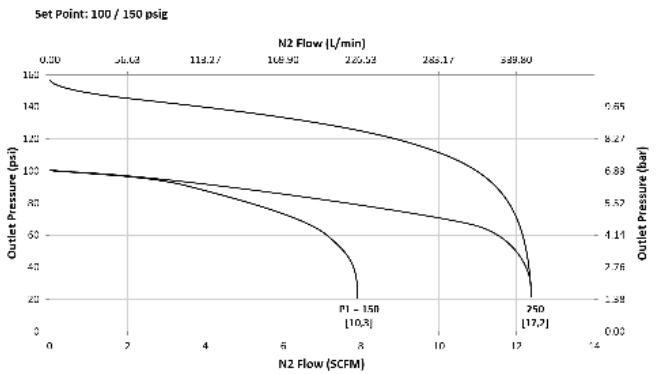

FLOW DATA FOR Cv TRIM SELECTION

The graphs illustrate the change or "droop" in outlet pressures as the flow rate increases, and the lockup (setpoint rise) as flow decreases and approaches zero.

Flow Coefficient: 0.08

Pressure Control Range

Range Spring: 75 - 250 psig (5,17 - 17,23 bar)

Set Point: 200/250 psig (13,78/17,23 bar)

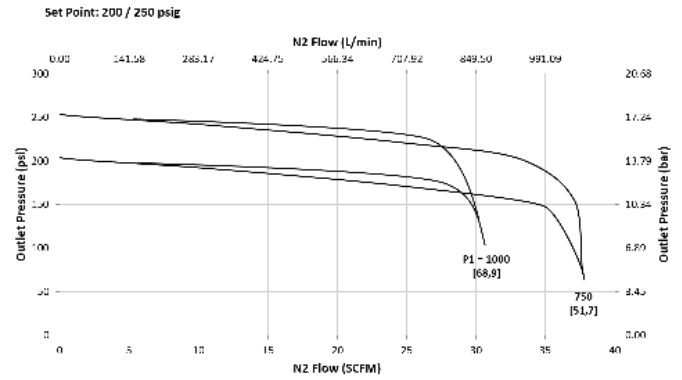
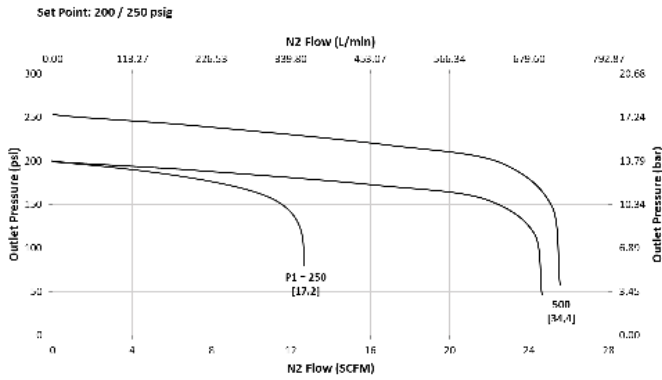

Pressure Control Range

Range Spring: 100 - 475 psig (6,89 - 32,75 bar)

Set Point: 100 psig (6,89 bar)

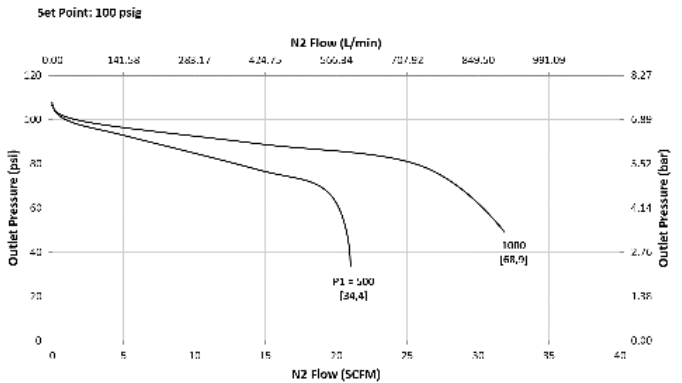
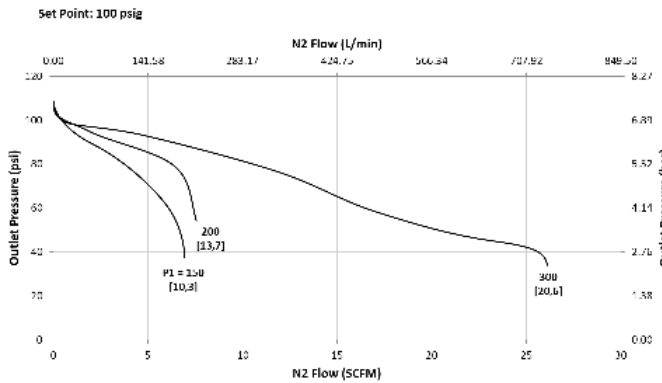

Pressure Control Range

Range Spring: 100 - 475 psig (6,89 - 32,75 bar)

Set Point: 150 psig (10,34 bar)

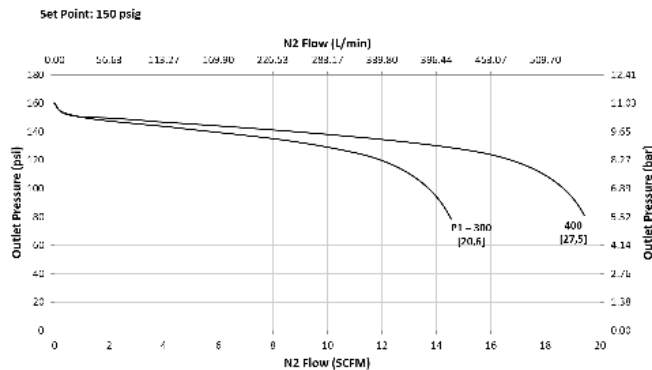

FLOW DATA FOR CV TRIM SELECTION

The graphs illustrate the change or "droop" in outlet pressures as the flow rate increases, and the lockup (setpoint rise) as flow decreases and approaches zero.

Flow Coefficient: 0.08

Pressure Control Range

Range Spring: 100 - 475 psig (6,89 – 32,75 bar)

Set Point: 150/200/250 psig (10,34/13,78/17,23 bar)

Pressure Control Range

Range Spring: 200 - 750 psig (13,78 – 51,71 bar)

Set Point: 200/250/500/750 psig (13,78/17,23/34,47/51,71 bar)

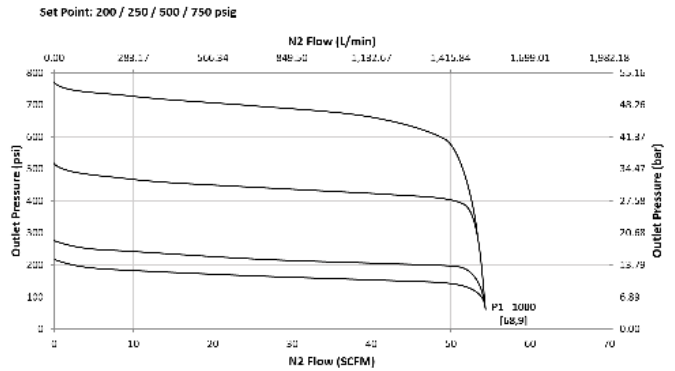
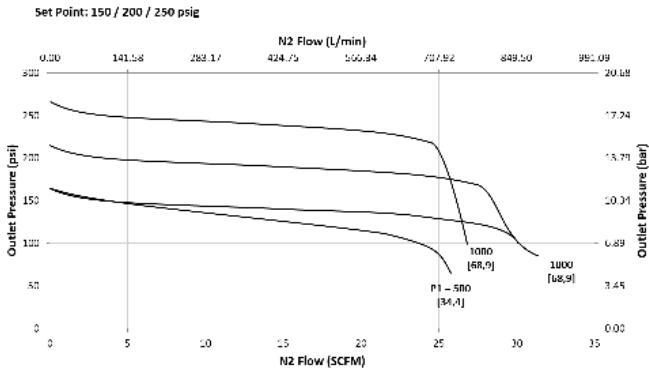

Flow Coefficient: 0.20

Pressure Control Range

Range Spring: 5-50 psig (0,34 - 3,44 bar)

Set Point: 25/50 psig (1,72/3,44 bar)

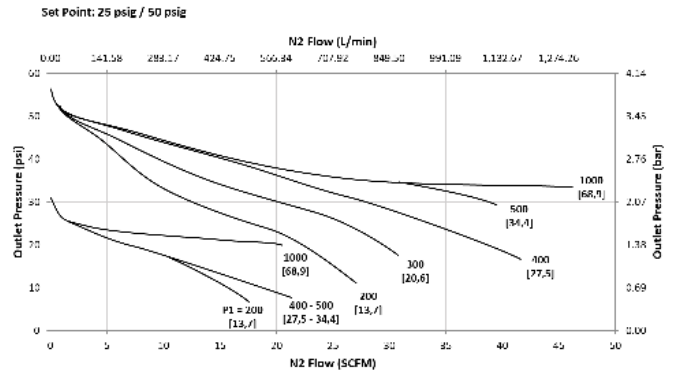
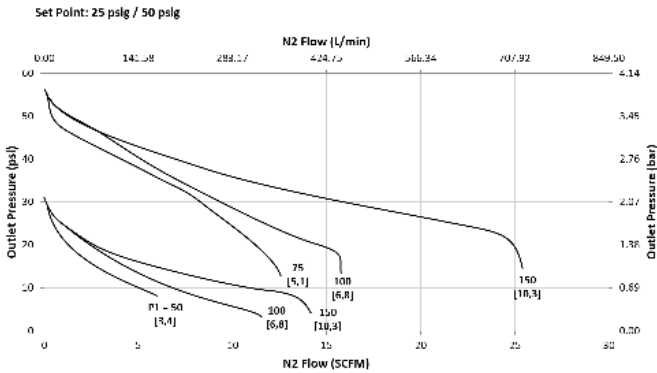

Flow Coefficient: 0.20

Pressure Control Range

Range Spring: 25-100 psig (1,72 – 6,89 bar)

Set Point: 25 psig (1,72 bar)

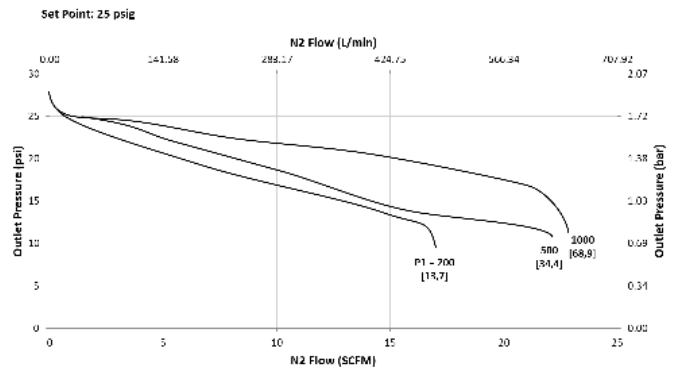
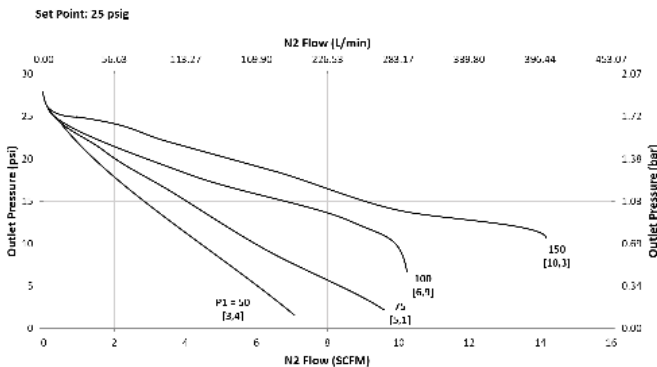

FLOW DATA FOR Cv TRIM SELECTION

The graphs illustrate the change or "droop" in outlet pressures as the flow rate increases, and the lockup (setpoint rise) as flow decreases and approaches zero.

Flow Coefficient: 0.20

Pressure Control Range

Range Spring: 25-100 psig (1,72 – 6,89 bar)

Set Point: 50 psig (3,44 bar)

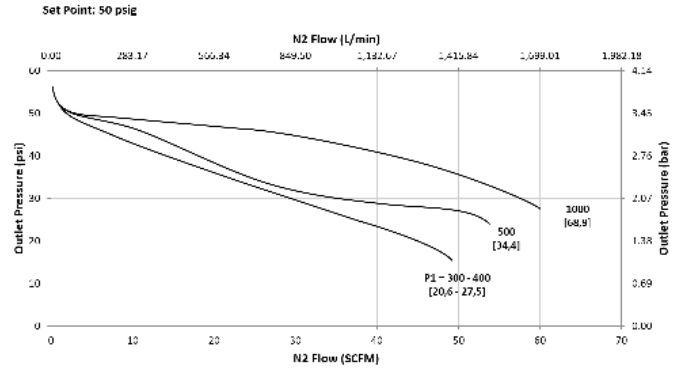
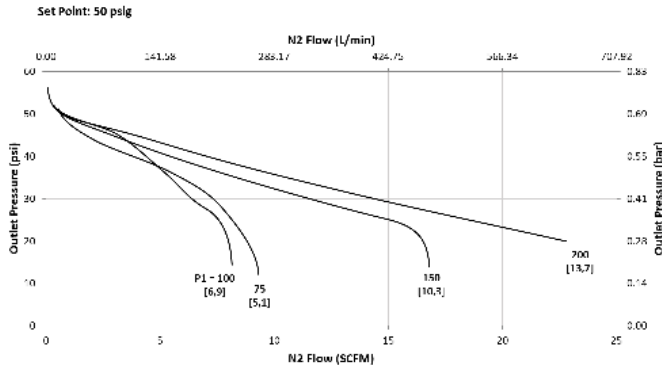

Pressure Control Range

Range Spring: 25-100 psig (1,72 – 6,89 bar)

Set Point: 75 psig (5,17 bar)

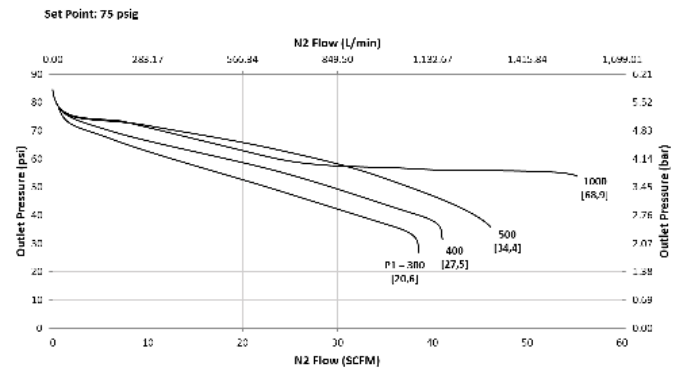
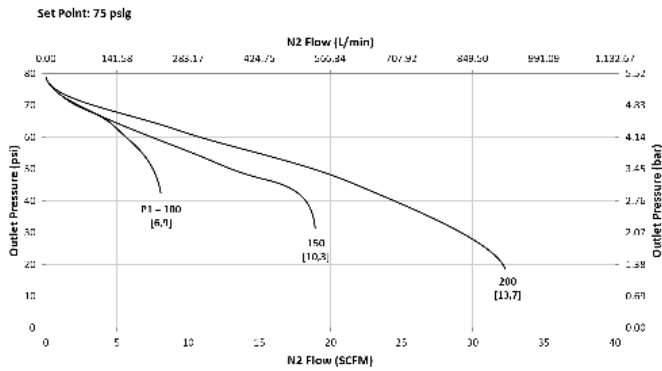

Pressure Control Range

Range Spring: 25 - 100 psig (1,72 - 6,89 bar)

Set Point: 100 psig (6,89 bar)

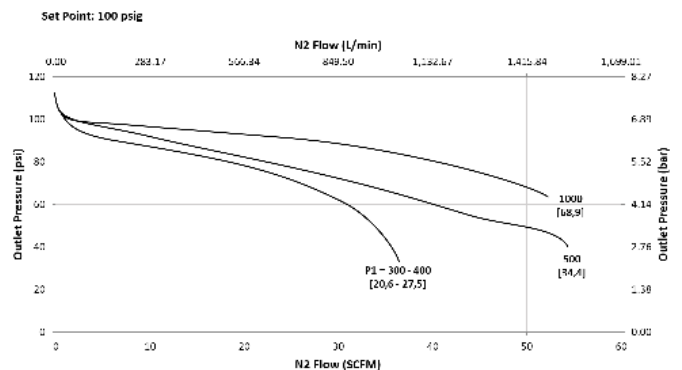
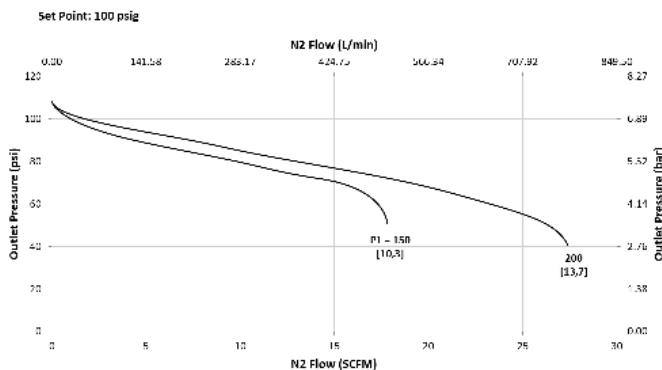

FLOW DATA FOR Cv TRIM SELECTION

The graphs illustrate the change or "droop" in outlet pressures as the flow rate increases, and the lockup (setpoint rise) as flow decreases and approaches zero.

Flow Coefficient: 0.20

Pressure Control Range

Range Spring: 50-150 psig (3,44 – 10,34 bar)

Set Point: 50 psig (3,44 bar)

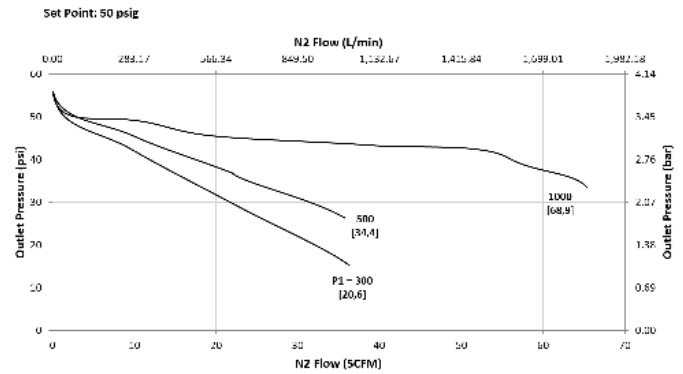
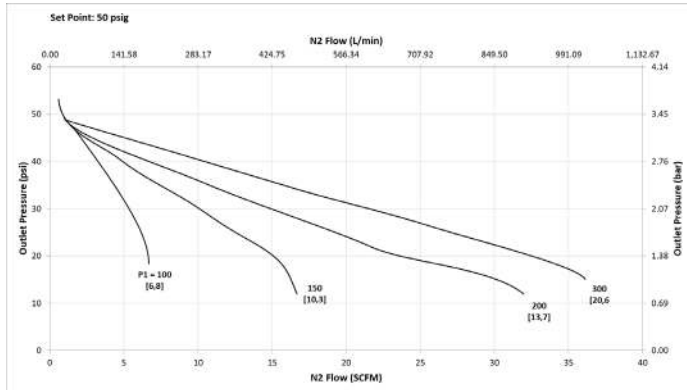

Pressure Control Range

Range Spring: 50-150 psig (3,44 – 10,34 bar)

Set Point: 75 psig (5,17 bar)

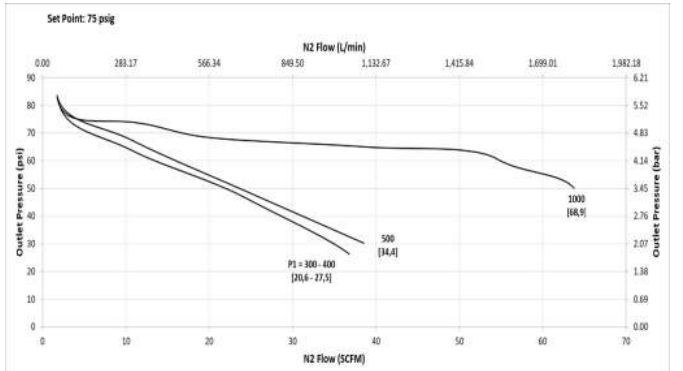
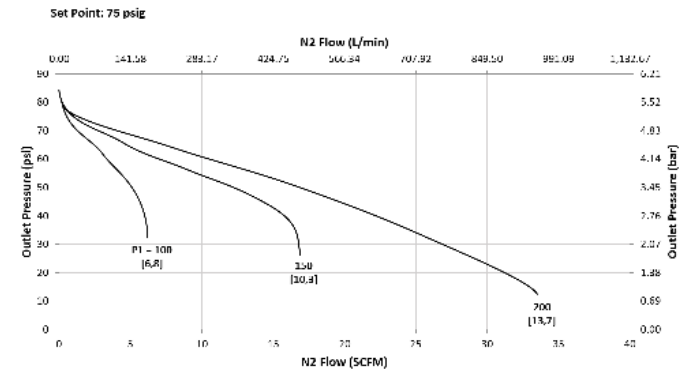

Pressure Control Range

Range Spring: 50-150 psig (3,44 – 10,34 bar)

Set Point: 100 psig (6,89 bar)

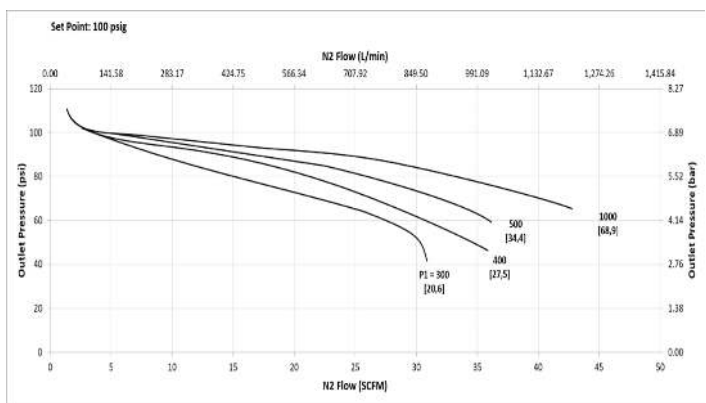
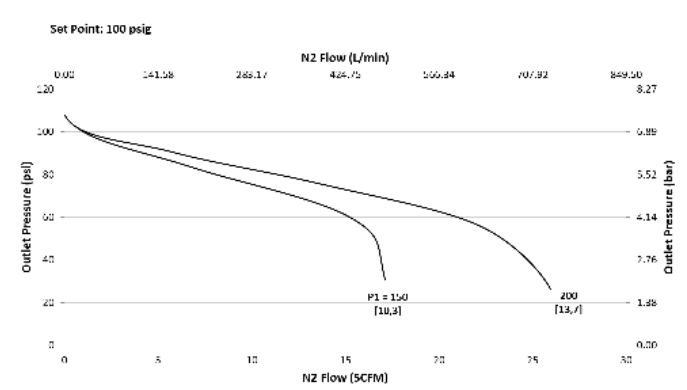

FLOW DATA FOR Cv TRIM SELECTION

The graphs illustrate the change or "droop" in outlet pressures as the flow rate increases, and the lockup (setpoint rise) as flow decreases and approaches zero.

Flow Coefficient: 0.20

Pressure Control Range

Range Spring: 50-150 psig (3,44 – 10,34 bar)

Set Point: 150 psig (10,34 bar)

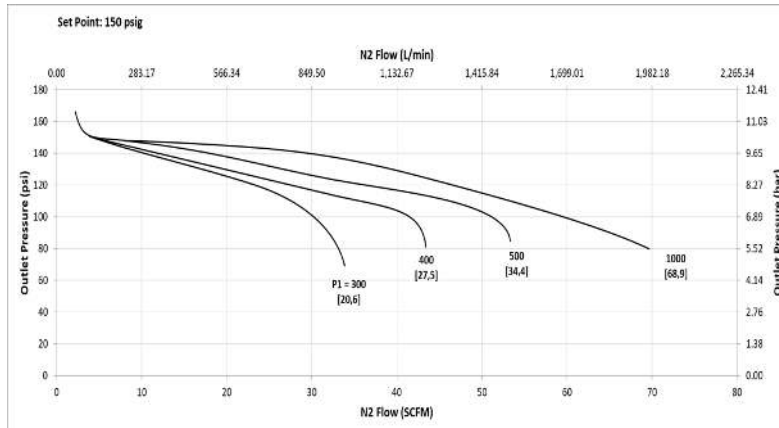

Pressure Control Range

Range Spring: 75-250 psig (5,17 – 17,23 bar)

Set Point: 75 psig (5,17 bar)

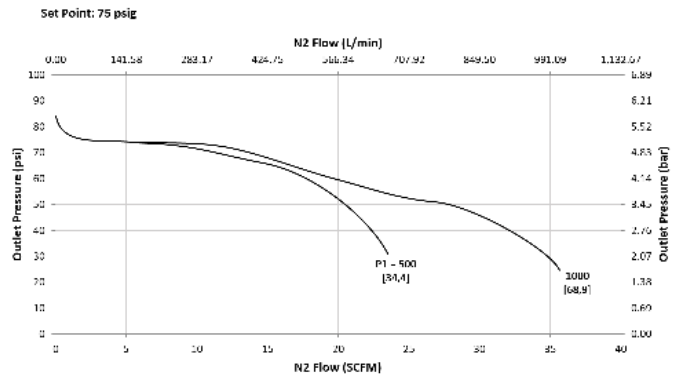
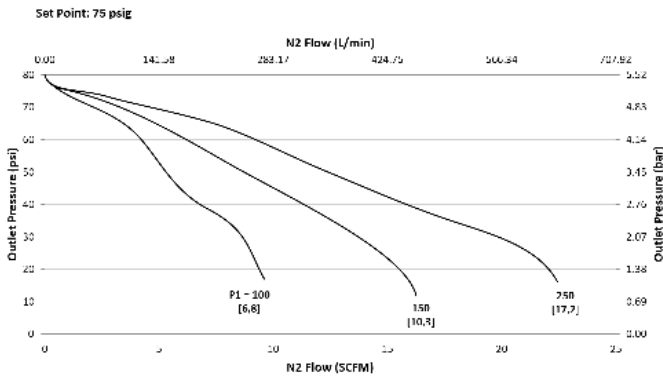

Pressure Control Range

Range Spring: 75-250 psig (5,17 – 17,23 bar)

Set Point: 100/150 psig (6,89/10,34 bar)

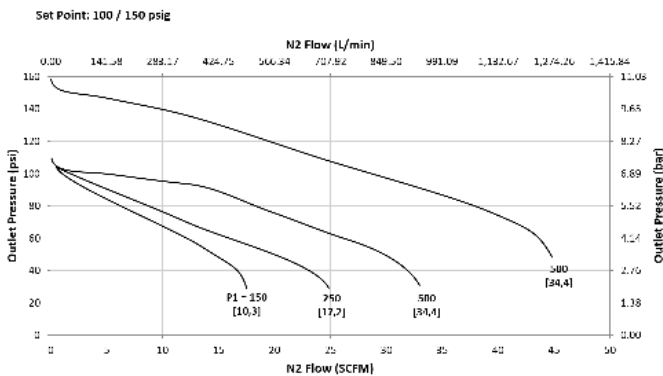

Pressure Control Range

Range Spring: 75-250 psig (5,17 – 17,23 bar)

Set Point: 200 psig (13,78 bar)

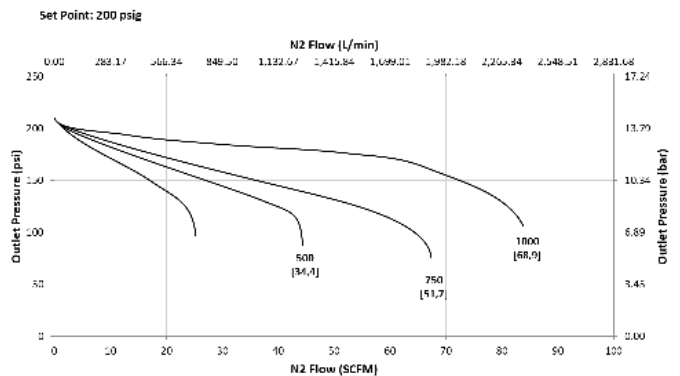

FLOW DATA FOR CV TRIM SELECTION

The graphs illustrate the change or "droop" in outlet pressures as the flow rate increases, and the lockup (setpoint rise) as flow decreases and approaches zero.

Flow Coefficient: 0.20

Pressure Control Range

Range Spring: 75-250 psig (5,17 – 17,23 bar)

Set Point: 250 psig (17,23 bar)

Pressure Control Range

Range Spring: 100-475 psig (6,89 – 32,75 bar)

Set Point: 100 psig (6,89 bar)

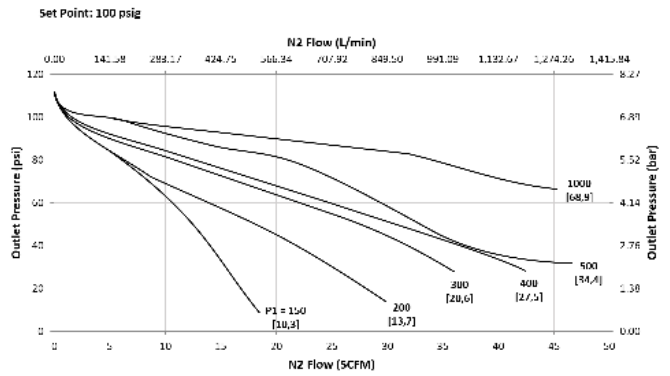
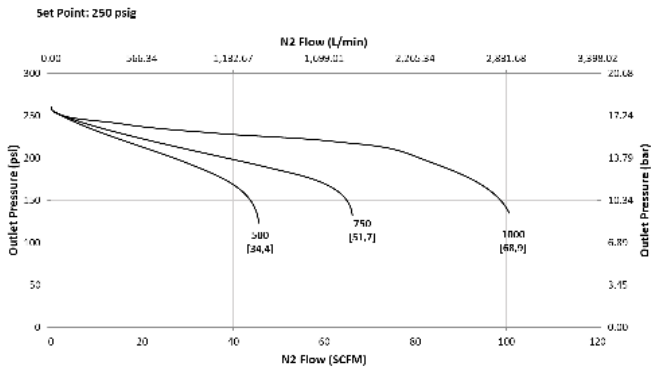

Pressure Control Range

Range Spring: 100-475 psig (6,89 – 32,75 bar)

Set Point: 150 psig (10,34 bar)

Pressure Control Range

Range Spring: 100-475 psig (6,89 – 32,75 bar)

Set Point: 200/250 psig (13,78/17,23 bar)

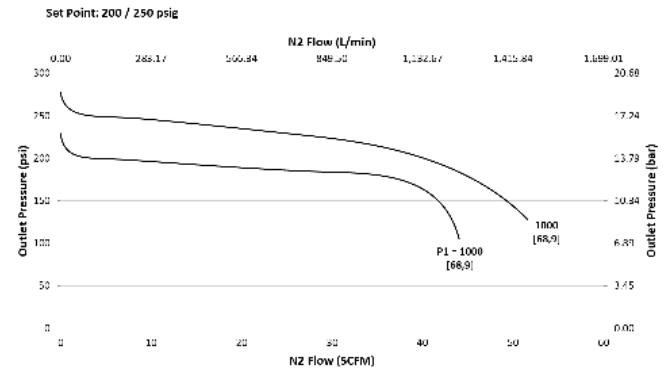
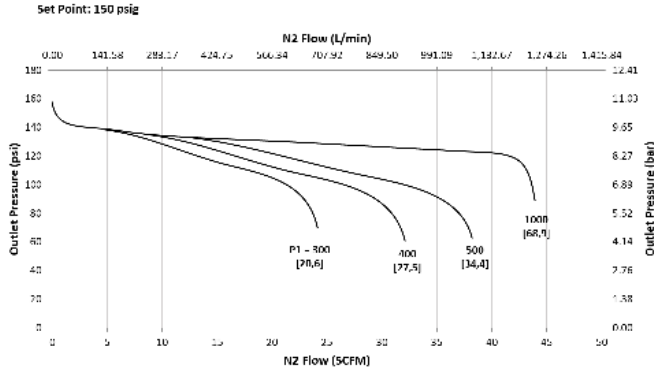

Pressure Control Range

Range Spring: 200-750 psig (13,78 – 51,71 bar)

Set Point: 200/250/500/750 psig (13,78/17,23/34,47/51,71 bar)

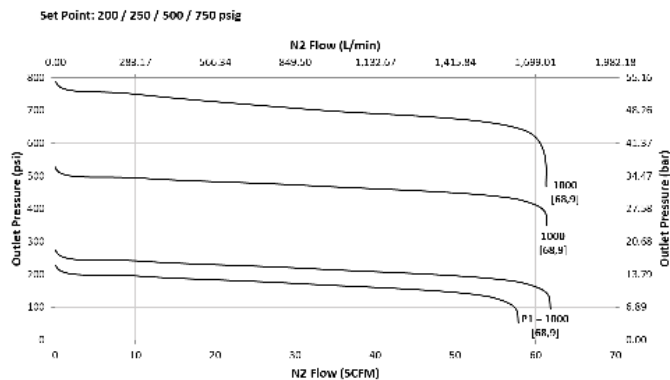

JSRLF SERIES LOW FLOW PRESSURE REDUCING VALVE

JSRLF ORDERING SCHEMATIC (SEE PG 32 FOR JSRLFE (EPDM SEAT) ORDERING SCHEMATIC)

Model	Size	Material	1 & 2	3 & 4	5 & 6	7 & 8	9 & 10	11 & 12	13 & 14	15	16	17
—	—	—	/									

Model	
JSRLF	Low Flow Pressure Reducing Valve

Size	
025	1/4" (DN08)
038	3/8" (DN10)
050	1/2" (DN15)

Material	
6L	ASTM A479, 316L

1	Body Feature End Connection	2	Body Feature Port Configuration*
ASME BPE Selections			
A	FNPT, 1/4"	A	Port "A"
B	FNPT, 3/8"	B	Port "B"
C	FNPT, 1/2"	C	Port "C"
T	ASME BPE Tri-Clamp, 1/2"	D	Port "D"
W	ASME BPE Tube Weld, 1/2"	E	Port "E"
ISO Selections			
H ⁴	ISO Tube Weld, DN15	* Std. Gauge Ports are 1/4" FNPT. Contact factory for availability of others	
S ¹	ISO Tri-Clamp, DN15		
V ¹	ISO w/ 34.0mm face T-Clamp, DN15		
R ¹	ISO T-Clamp, DN20		
DIN Selections			
D ²	DIN Tri-Clamp, DN15		
N ²	DIN T-Clamp, DN15 w/50.5mm face		
U ²	DIN T-Clamp, DN20		
X ²	DIN T-Clamp, DN20 w/50.5mm face		
M ³	DIN Tube Weld, DN15		
ZZ	Non-Standard		

¹ Acc. to DIN 32676 Row B (ISO 1127). See dimensions, page 4

² Acc. to DIN 32676 Row A. See dimensions, page 4

³ Acc. to DIN 11866, DIN 11850 Row A

⁴ Acc. to DIN 11866 Row B

3 & 4	Trim
1S	Cv 0.012
2S	Cv 0.08
3S	Cv 0.2
4S*	Cv 0.03
1R	Cv 0.012 Self-Relieving**
2R	Cv 0.08 Self-Relieving**
3R	Cv 0.2 Self-Relieving**
4R*	CV 0.03 Self-Relieving**
ZZ	Non-Standard

* Though out of sequence, "4S" and "4R" are the correct order codes for Cv 0.03

** You cannot choose the Self-Relieving option if using the Capture Vent option for Air-Loading. See Page 3 for complete description.

5 & 6	Seat Material - FDA & USP Class VI		
T1	PTFE Cv 0.012	P2	PEEK Cv 0.08
T2	PTFE Cv 0.08	P3	PEEK Cv 0.2
T3	PTFE Cv 0.2	P4	PEEK Cv 0.03
T4	PTFE Cv 0.03	ZZ	Non-Standard
P1	PEEK Cv 0.012		

7 & 8	Range Spring / Outlet Pressure		
E1	5 - 50 psi	E5	100 - 450 psi
E2	25 - 100 psi	E6	200 - 750 psi (NPT only)
E3	50 - 150 psi		
E4	75 - 250 psi	ZZ	Non-Standard

9 & 10	Diaphragm Material
JL	Jorlon™ PTFE, FDA & USP Class VI
ZZ	Non-Standard

11 & 12	Actuator
SK	Standard Actuator
AK	Standard Actuator / Autoclavable Anod. Aluminum knob
PM	Panel Mount (See illustration page 3)
CV ¹	Captured Vent provides fitting on spring housing for venting self-relieved gas
AA ¹	Air Loading provides fitting for air input on spring housing, and a stem seat nut
TP	Anti-tamper feature (See illustration page 4)
ZZ	Non-Standard

¹ See page 3 for complete description

13 & 14	Inlet Gauge*		
AA	0 - 30 psi / bar (Dual)	JJ	0 - 1000 psi/bar (Dual) NPT only
BB	0 - 60 psig / bar (Dual)	KK	0 - 2000 psi/bar (Dual) NPT only
CC	0 - 100 psig / bar (Dual)	LL	0 - 3000 psi/bar (Dual) NPT only
DD	0 - 160 psig / bar (Dual)	MM	0 - 5000 psi/bar (Dual) NPT only
EE	0 - 200 psig / bar (Dual)	NN	No Gauge - if gauge ported body option selected
FF	0 - 300 psig / bar (Dual)	00	No Gauge - if Port "A" Body Feature chosen
GG	0 - 400 psig / bar (Dual)	ZZ	Non-Standard
HH	0 - 600 psig/bar (Dual) NPT only		

* Customer assumes all responsibility for possible damage or injury if selected gauge span does not fully cover range spring / outlet pressure option

15	Outlet Gauge*
A	0 - 30 psig
B	0 - 60 psig / bar (Dual)
C	0 - 100 psig / bar (Dual)
D	0 - 160 psig / bar (Dual)
E	0 - 200 psig / bar (Dual)
F	0 - 300 psig / bar (Dual)
G	0 - 400 psig / bar (Dual)
H	0 - 600 psig / bar (Dual) NPT only
J	0 - 1000 psi / bar (Dual) NPT only
N	No Gauge - if gauge ported body option selected
O	No Gauge - if Port "A" Body Feature chosen
Z	Non-Standard

* Customer assumes all responsibility for possible damage or injury if selected gauge span does not fully cover range spring / outlet pressure option

JSRLF SERIES LOW FLOW PRESSURE REDUCING VALVE

JSRLF ORDERING SCHEMATIC (SEE PG 32 FOR JSRLFE (EPDM SEAT) ORDERING SCHEMATIC)

Model	Size	Material	/	1 & 2	3 & 4	5 & 6	7 & 8	9 & 10	11 & 12	13 & 14	15	16	17
	—	—											

16	SEP Compliance
G	SEP Compliant
Ø	None
Z	Non-Standard

17	Accessories
S	Clean For Oil Free
X	Clean For Oxygen ²
J	Clean for Oxygen, Assemble Dry ^{1,2}
A	EN10204 3.1 Cert for Wetted Parts
Ø	None
Z	Non-Standard

¹ Procedure complies with ASTM G-93 2011 and CGA G-4.1-2009

² Use of Oxygen safe lubricant (Krytox™ for example) can affect gas line particulate testing. Assembling all wetted components dry (without lubricant) removes that effect, however it may increase the difficulty in disassembly/reassembly of valve seat components during valve maintenance. Note that we will use O2 safe lubricant on non-wetted threaded components.

JSRLF (EDPM SEAT) ORDERING SCHEMATIC

Model	Size	Material	/	1 & 2	3 & 4	5 & 6	7 & 8	9 & 10	11 & 12	13 & 14	15	16	17
—	—	—	/										

Model	
JSRLF	Low Flow Pressure Reducing Valve (EDPM Seat)

Size	
025	1/4" (DN08)
038	3/8" (DN10)
050	1/2" (DN15)

Material	
6L	ASTM A479, 316L

1	Body Feature End Connection	2	Body Feature Port Configuration*
ASME BPE Selections			
A	FNPT, 1/4"	A	Port "A"
B	FNPT, 3/8"	B	Port "B"
C	FNPT, 1/2"	C	Port "C"
T	ASME BPE Tri-Clamp, 1/2"	D	Port "D"
W	ASME BPE Tube Weld, 1/2"	E	Port "E"
ISO Selections			
H ⁴	ISO Tube Weld, DN15	* Std. Gauge Ports are 1/4" FNPT. Contact factory for availability of others	
S ¹	ISO Tri-Clamp, DN15		
V ¹	ISO w/ 34.0mm face T-Clamp, DN15		
R ¹	ISO T-Clamp, DN20		
DIN Selections			
D ²	DIN Tri-Clamp, DN15		
N ²	DIN T-Clamp, DN15 w/50.5mm face		
U ²	DIN T-Clamp, DN20		
X ²	DIN T-Clamp, DN20 w/50.5mm face		
M ³	DIN Tube Weld, DN15		
ZZ	Non-Standard		

¹ Acc. to DIN 32676 Row B (ISO 1127). See dimensions, page 3
² Acc. to DIN 32676 Row A. See dimensions, page 3
³ Acc. to DIN 11866, DIN 11850 Row A
⁴ Acc. to DIN 11866 Row B

3 & 4	Trim
1S	Cv 0.012
2S	Cv 0.08
3S	Cv 0.2
4S	Cv 0.03
1R	Cv 0.012 Self-Relieving, PTFE*
2R	Cv 0.08 Self-Relieving, PTFE*
3R	Cv 0.2 Self-Relieving, PTFE*
4R	CV 0.03 Self-Relieving, PTFE*
ZZ	Non-Standard

* You cannot choose the Self-Relieving option if using the Capture Vent option for Air-Loading. See Page 3 for complete description.

5 & 6	Seat Material
D1	EPDM Cv 0.012
D2	EPDM CV 0.08
D3	EPDM C 0.20
D4	EPDM CV 0.03
ZZ	Non-Standard

7 & 8	Range Spring / Outlet Pressure
E1	5 - 50 psi
E2	25 - 100 psi
E3	50 - 150 psi
E4	75 - 250 psi
E5	100 - 450 psi
ZZ	Non-Standard

9 & 10	Diaphragm Material
JL	Jorlon™ PTFE, FDA & USP Class VI
ZZ	Non-Standard

11 & 12	Actuator
Ranges E1 thru E5	
SK	Standard Actuator
CV ¹	Captured Vent provides fitting on spring housing for venting self-relieved gas
AA ¹	Air Loading provides fitting for air input on spring housing, and a stem seat nut
PM	Panel Mount
TP	Anti-tamper feature (See illustration page 4)
ZZ	Non-Standard

¹ See page 3 for complete description

13 & 14	Inlet Gauge*
AA	0 - 30 psi / bar (Dual)
BB	0 - 60 psig / bar (Dual)
CC	0 - 100 psig / bar (Dual)
DD	0 - 160 psig / bar (Dual)
EE	0 - 200 psig / bar (Dual)
FF	0 - 300 psig / bar (Dual)
GG	0 - 400 psig / bar (Dual)
NN	No Gauge - if gauge ported body option selected
00	No Gauge - if Port "A" Body Feature chosen
ZZ	Non-Standard

* Customer assumes all responsibility for possible damage or injury if selected gauge span does not fully cover range spring / outlet pressure option

15	Outlet Gauge*
A	0 - 30 psig
B	0 - 60 psig / bar (Dual)
C	0 - 100 psig / bar (Dual)
D	0 - 160 psig / bar (Dual)
E	0 - 200 psig / bar (Dual)
F	0 - 300 psig / bar (Dual)
G	0 - 400 psig / bar (Dual)
N	No Gauge - if gauge ported body option selected
00	No Gauge - if Port "A" Body Feature chosen
Z	Non-Standard

* Customer assumes all responsibility for possible damage or injury if selected gauge span does not fully cover range spring / outlet pressure option

16	SEP Compliance
G	SEP Compliant
Ø	None
Z	Non-Standard

17	Accessories
S	Clean For Oil Free
X	Clean For Oxygen ³
J	Clean for Oxygen, Assemble Dry ^{2,3}
A	EN10204 3.1 Cert for Wetted Parts
Ø	None
Z	Non-Standard

*Procedure complies with ASTM G-93 2011 and CGA G-4.1-2009

¹Use of Oxygen safe lubricant (Krytox™ for example) can affect gas line particulate testing. Assembling all wetted components dry (without lubricant) removes that effect, however it may increase the difficulty in disassembly/reassembly of valve seat components during valve maintenance. Note that we will use O2 safe lubricant on non-wetted threaded components.