

JSRLP Series

Low Pressure Reducing Valves for Bio-Pharm Gas Applications

JSRLP is a high purity gas low pressure regulator designed and built specifically for hygienic, ASME BPE gas applications.

The JSRLP has been designed specifically for low pressure clean gas regulation in Stainless and Single use disposable applications. Whether it's precise regulation for sparging, blanketing, motive force, or SUD bag inflation, the JSRLP was built for the job!

The durable valve body and metal trim components are machined from ASTM A479 316L SST barstock and finished to ASME BPE SF5 (20Ra micro-inch, electropolished) standard. The valve is outfitted with a thin Jorlon diaphragm and Teflon, PEEK, or EPDM seats and seals that are all FDA approved, USP Class VI compliant materials. These materials of construction enable JSRLP to withstand the rigors of an autoclave if required. The EPDM seat reduces lockup to less than 0.5 psig on this model.

FEATURES

- No exposed threaded connections below diaphragm
- In-line removable seat and trim facilitate cleaning and routine maintenance
- Barstock construction guarantees material integrity and surface finish
- Very low lockup with EPDM seat material
- High rangeability and relatively low set point offset lessens the need for reduced trim sizes
- Minimized internal volume
- Proprietary Jorlon diaphragm material provides exceptionally long life and Autoclave capability
- Soft seat material for ANSI Class VI shutoff

DOCUMENTATION

The following documentation is shipped at no charge:

- Steriflow Unicert, a QC signed Certificate of Compliance for:
 - Material, listing heat numbers with attached MTR's
 - Surface Finish
 - FDA/USP Class VI - for all thermoplastic and elastomers
- Traceability:
 - Each individual product serial number is traceable to the Unicert serial number, heat numbers and attached MTR's

Other documents must be requested at time of RFQ, or order:

- ADI/TSE Free, Certified Test reports, Certificate of Origin.

New!

- Air Augment Option
- EPDM seat for low lockup and tight shutoff



APPLICATIONS

The JSRLP is a Pressure Regulating valve ideal for low flow, low pressure precision regulation of clean compressed air and gas used in pharmaceutical and biopharmaceutical R&D, Pilot, and Production facilities.

It is designed specifically for use on traditional Stainless Steel and Single Use Disposable applications including:

- Small sterile vessels:
 - Gas overlay (blanketing)
 - Sparging
 - SUD bag integrity testing/inflation
- Incubators
- Lyophilizers
- Time/pres filling machine product hold vessels

Suitable for clean compressed gas, including:

- Air
- Nitrogen
- Carbon Dioxide
- Oxygen
- Argon
- Custom gas mixtures

SPECIFICATIONS

Sizes: 1/2" (DN15) & 3/4" (DN20)

End Connections: ASME BPE, DIN, ISO Tri-clamp, or Tube Weld end; NPT

Gauge Ports: 1/4" FNPT is standard. Contact Factory for Tri-Clamp, VCR, or other alternatives.

Soft Seat Materials for ANSI Class VI Shut-Off:

- PTFE to +252°F (122°C) continuous or 275°F (135°C) intermittent [not to exceed 15 min. in a one hour period] FDA, USP Class VI
- PEEK to +350°F (176,7°C) FDA, USP Class VI
- EPDM to +300°F (150°C) FDA, USP Class VI*

Body Material: ASME SA479 316L (UNS 31603) is standard. EN 10272:2000 GR 1.4435, AL-6XN®, Hastelloy®C-22 and others are optional.

Diaphragm Material: Thin Jorlon FDA, USP Class VI

Maximum Inlet Pressure: 150 psig (10,5 bar)

Optional Cleaning Specifications

- Clean for Oil-Free
- O2 Cleaning complying with ASTM G93-03 2011 and CGA G-4.1-2009

Note: For a complete ancillary list of all wetted and non-wetted material specifications, please contact Steriflow Valve.

Spring Ranges: 1-5 psi (0,07-0,3 bar); 5-15 psi (0,3-1,0 bar); 15-25 psi (1,0-1,7 bar); 25-50 psi (1,7-3,4 bar)

* Suggested for low lockup and tight shutoff on no flow or deadhead blanketing applications.

Flow Characteristics:

- High Flow: Trim Cv 0.8; Cv for relief valve sizing is 1.9
- Low Flow: Trim Cv 0.5; Cv for relief valve sizing is 0.6

Surface Finish:

- Wetted Internal surface finish: Mechanically polished, and electropolished to ASME BPE SF5, 20 Ra µin (0.5 Ra µm) as standard
- Exterior surface finish: Mechanically polished, and electropolished to 40 Ra µin (1.0 Ra µm) as standard
- Other finishes available upon request

Options:

- Panel Mounting
- Captured Vent
- Self Relieving
- Gauge ports, pressure gauges
- Air Augment

OPTION DEFINITION

Captured Venting

The captured vent option provides a means to vent downstream, self-relieved gas. To enable this function, a 1/8" FNPT collar is installed on the spring housing. This feature provides a means to safely transport toxic or hazardous, self-relieved downstream gas away from the spring housing via tubing to a safe area.

!VIP! This option must be specified with the Self-Relieving* option if the user wishes to transport self-relieved vented gas to a safe location.

Air Augment

The air augment option provides a means for air loading the valve spring housing for automated control. To enable this function a 1/8" FNPT collar is installed on the spring housing (the same one used for the captured vent option), and a Teflon seal nut is included to seal the adjusting screw threads to prevent leakage. The 1/8" FNPT port is used as the input fitting for loading the spring housing with instrument air to completely automate or augment manual regulator control. An I/P transducer, or a small, self-relieving air set PRV regulator is required (ordered separately) to regulate the instrument air pressure.

***Self-Relieving**

The self-relieving option provides an internal mechanism to vent downstream pressure increase (above the set-point) through the spring housing and out a vent hole in the spring housing. If the gas is toxic, or dangerous - the Captured-Vent option (above) must also be specified. The Self-Relieving option allows for immediate pressure reduction when reducing the set point, provides a means to automatically relieve downstream pressure build-up when flow stops and the valve starts to close (sometimes called Lock-up), and alleviates pressure equalization across the orifice when the regulator is not operating.

!VIP! If selecting the Self-relieving option for a Toxic or Hazardous gas - the Captured Vent option must be selected. You cannot Air-Load if the Self-Relieving option is specified.

Panel Mount

The panel mounted regulator option illustrated on the next page requires a panel cut out of 1-1/2". When this option is specified, the regulator comes fitted with a threaded spring housing, and a panel mounting ring to secure the regulator to the panel.

Gauge Ports - Pressure Gauge

For inlet and outlet pressure gauges (and the gauges) are available as standard options

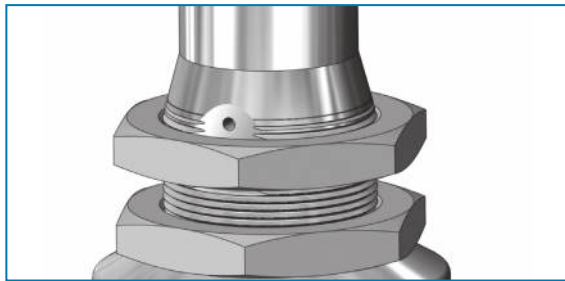

Panel Mount Option

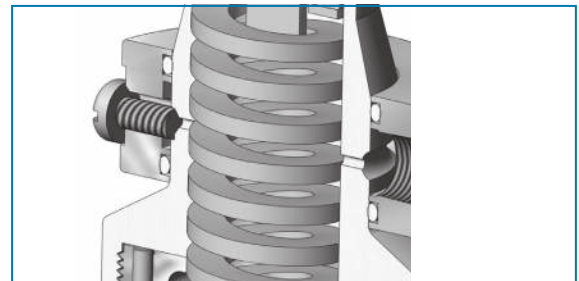

Captured Vent Option (1/8" NPT)

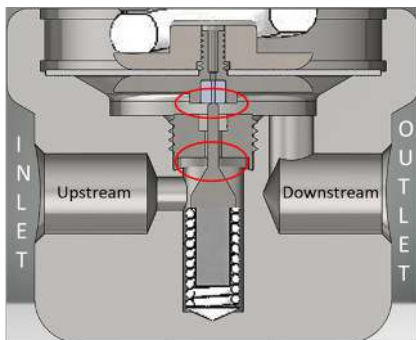

Figure 1: Self Relieving Valve in Closed Position when P2 = set point and flow stops

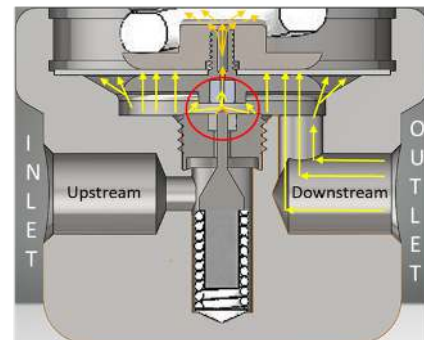

Figure 2: Self Relieving Valve in Closed Position when flow stops and P2 > set point. Showing overpressure release.

Concept illustration of Self-Relieving Option

FEATURES & BENEFITS

Reliable, gas pressure regulation with set points to 1 psig (69 millibar)

SST spring chamber suitable for washdown

Panel mount and captured vent - options available

FDA/USP Class VI seat and seal and material for ANSI Class VI shutoff

Sanitary clamp, extended tube weld, or FNPT connections available

NOTE: Can be used on clean steam or non-cavitating liquids (the design is not drainable) with Steriflow engineering application approval.

Optional:

- Autoclavable anodized aluminum handle
- Handle lockout device

Fine thread pitch for precision setpoint adjustments

Large Teflon diaphragm FDA/USP Class VI approved - for accurate low pressure control down to 1 psi

EPDM seat material available for extremely low lockup

ASME BPE SF5, 20 Ra μin (0,5 Ra μm) electropolish - finish - standard on internal surfaces and wetted parts

Bottom mounting (optional)

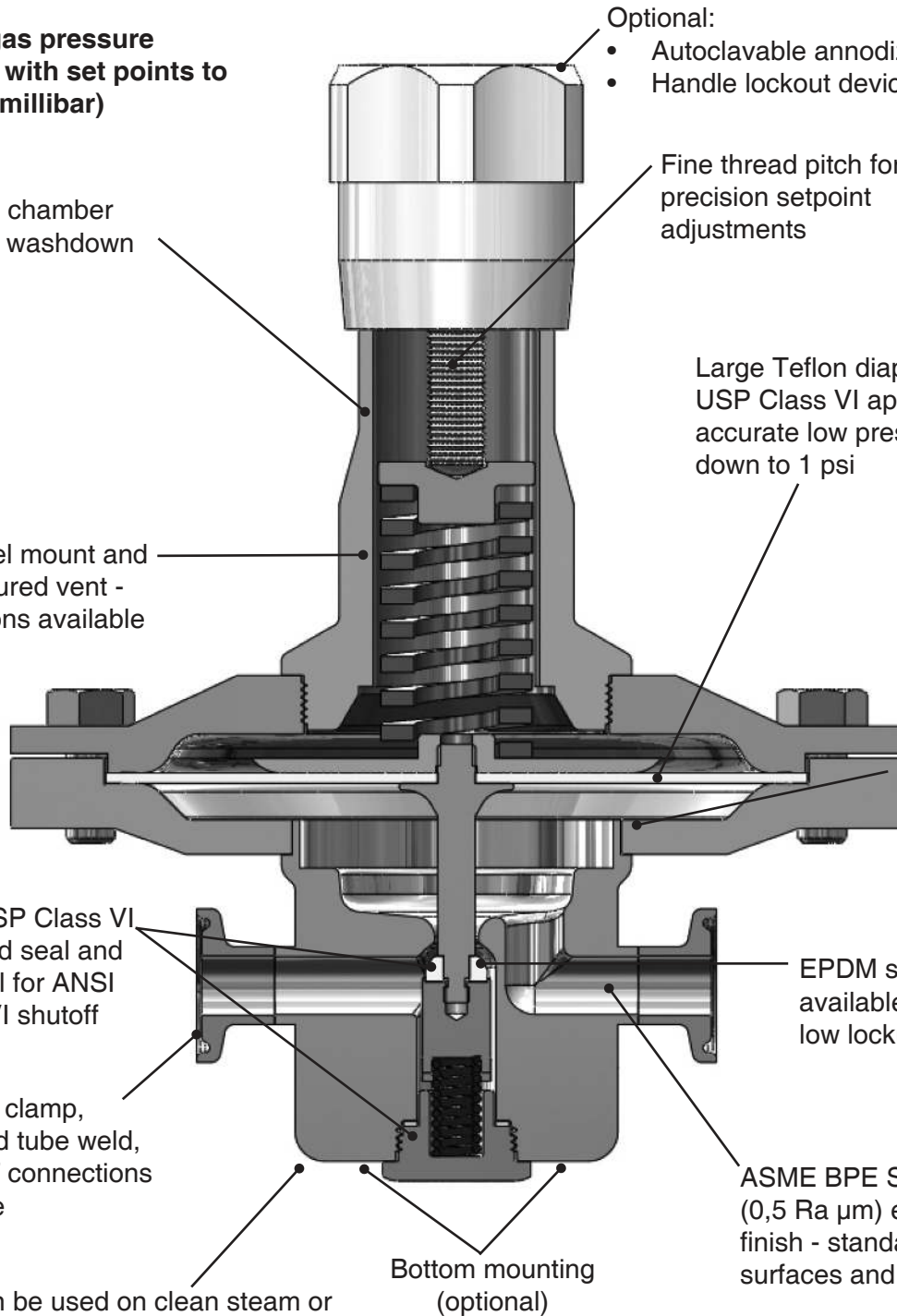

ANTI-TAMPER OPTION

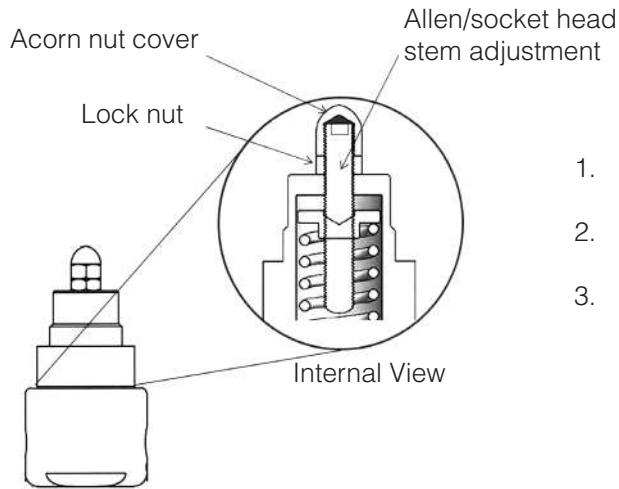

1. Adjust stem position with Allen wrench
2. Tighten lock nut against bonnet while holding stem position
3. Replace and tighten acorn nut

DIN & ISO TRI-CLAMP DIMENSIONS

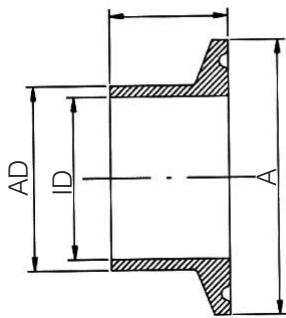

DIN 32676 Row B (ISO 1127)

VALVE SIZE	A	AD	ID
DN15	50.5	21.3	18.1
DN15*	34.0	21.3	18.1
DN20	50.5	26.9	23.7

* with non-standard Tri-clamp face

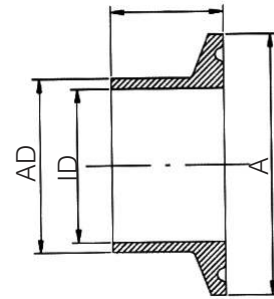

DIN 32676 Row A (DIN 11850)

VALVE SIZE	A	AD	ID
DN15	34.0	19.0	16.0
DN15*	50.5	19.0	16.0
DN20	34.0	23.0	20.0
DN20*	50.5	23.0	20.0

* with non-standard Tri-clamp face

Cv TRIM SELECTION INSTRUCTIONS

To select a valve with the proper Cv:

1. Select a graph on the following four pages that best represents your outlet pressure set point and flow range
2. Looking at that graph, select the closest inlet pressure line (horizontal sloped line, P1) that best reflects your application's actual inlet pressure. That line indicates the Pressure/Flow capabilities and offset (droop) of the trim (Flow Coefficient, Cv) under flowing conditions.
Note: If your exact outlet pressure set point or inlet pressure is not listed you will have to interpolate.
 - Your particular inlet pressure line will be very similar in length and slope to the line chosen on any particular graph.
 - The same is true for your outlet pressure set point, simply shift the line up or down.
3. The Cv is listed in bold at the upper left of the page of your chosen graph. You will need that for model number selection (See page 14).

GAS CONVERSION FACTORS

To convert gas flow rates to the air flow rates shown in the following graphs, multiply the gas flows by the conversion factor listed below.

For example: to convert an Argon flow range of 0.17 to 1.7 LPM to equivalent air flow rates that you can use with the graphs below, multiply each Argon flow rate by 1.18. The air flow range equivalent would be: (0.17 LPM Argon x 1.18) to (1.7 LPM Argon x 1.18), or 0.2 LPM Air to 2.0 LPM air.

Argon 1.18
Carbon Dioxide 1.23
Nitrogen 0.98
Oxygen 1.05

FLOW DATA FOR CV TRIM SELECTION

The graphs illustrate the change or "droop" in outlet pressures as the flow rate increases, and the lockup (setpoint rise) as flow decreases and approaches zero.

Flow Coefficient: 0.5

Maximum inlet pressure: 150 psig (10,3 bar)

Pressure Control Range

Range Spring: 1-5 psig (0-0,3 bar)

Set Point: 1 psig

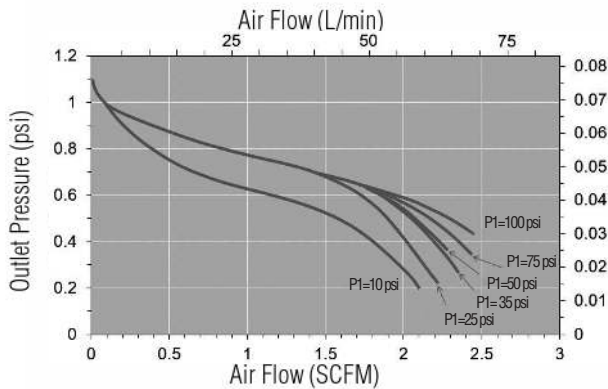

Pressure Control Range

Range Spring: 1-5 psig (0-0,3 bar)

Set Point: 2 psig

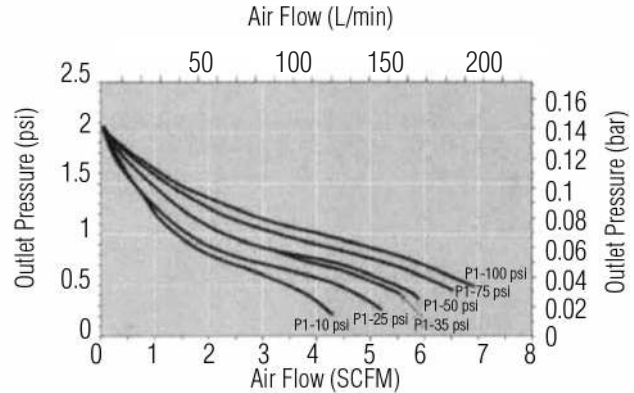

Pressure Control Range

Range Spring: 1-5 psig (0-0,3 bar)

Set Point: 5 psig

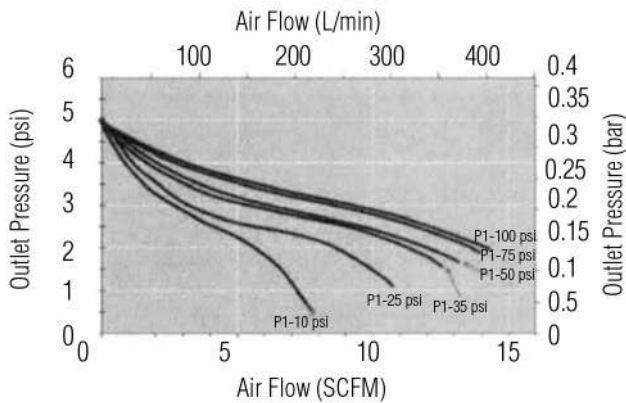

Pressure Control Range

Range Spring: 5-15 psig (0,3-1,0 bar)

Set Point: 10 psig

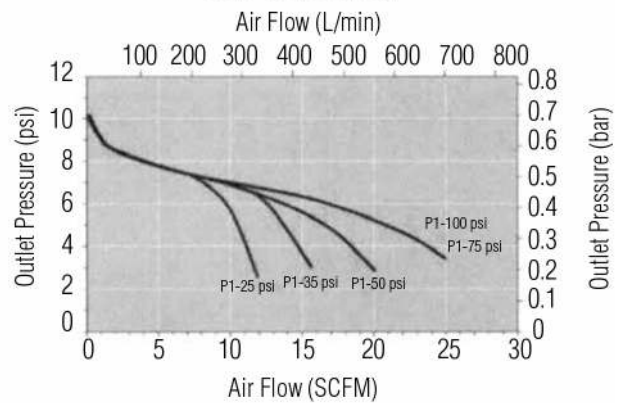

Pressure Control Range

Range Spring: 5-15 psig (0,3-1,0 bar)

Set Point: 15 psig

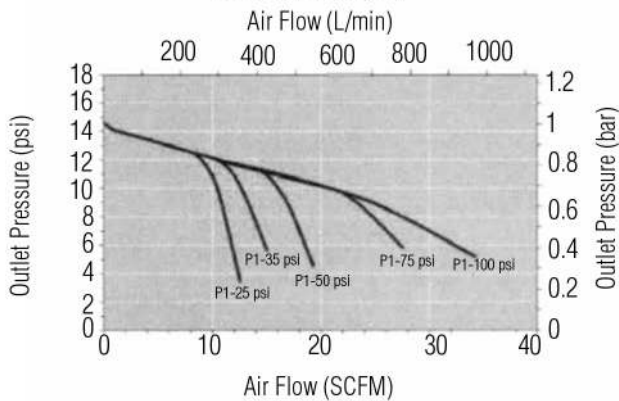

Pressure Control Range

Range Spring: 15-25 psig (1,0-1,7 bar)

Set Point: 20 psig

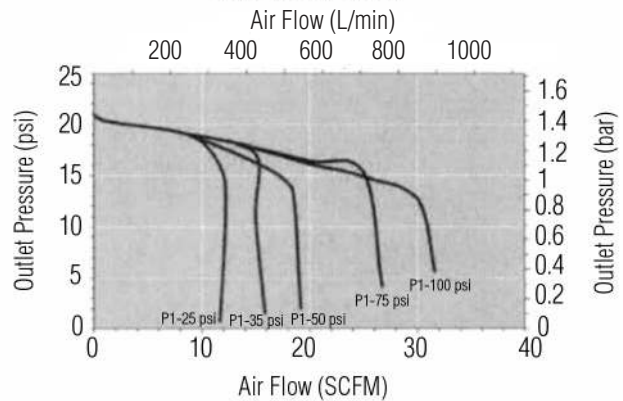

FLOW DATA FOR CV TRIM SELECTION

The graphs illustrate the change or "droop" in outlet pressures as the flow rate increases, and the lockup (setpoint rise) as flow decreases and approaches zero.

Flow Coefficient: 0.5

Maximum inlet pressure: 150 psig (10,3 bar)

Pressure Control Range

Range Spring: 25-50 psi (1,7 - 3,4 bar)

Set Point: 25 psig

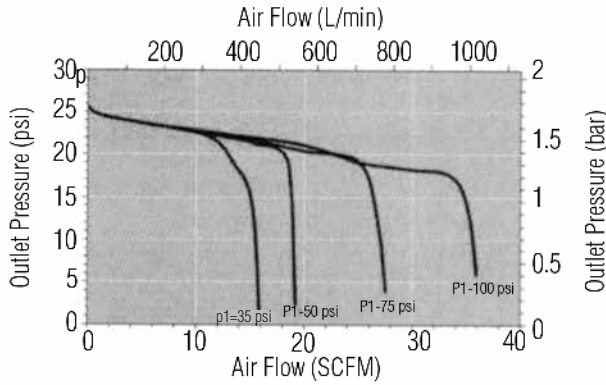

Pressure Control Range

Range Spring: 25-50 psi (1,7 - 3,4 bar)

Set Point: 30 psig

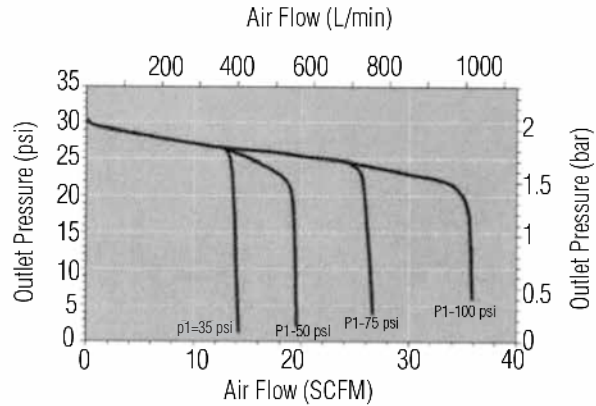

Pressure Control Range

Range Spring: 25-50 psig (1,7-3,4 bar)

Set Point: 35 psig

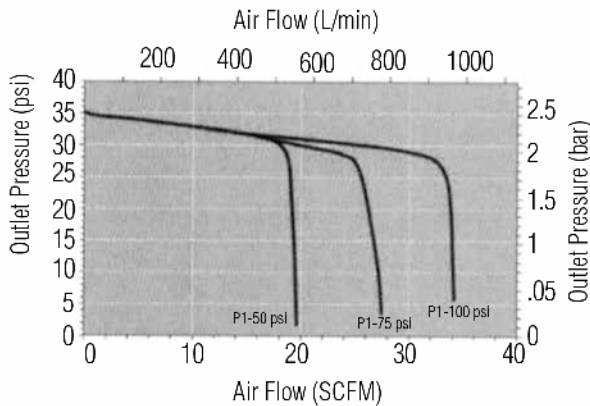

Pressure Control Range

Range Spring: 25-50 psig (1,7-3,4 bar)

Set Point: 40 psig

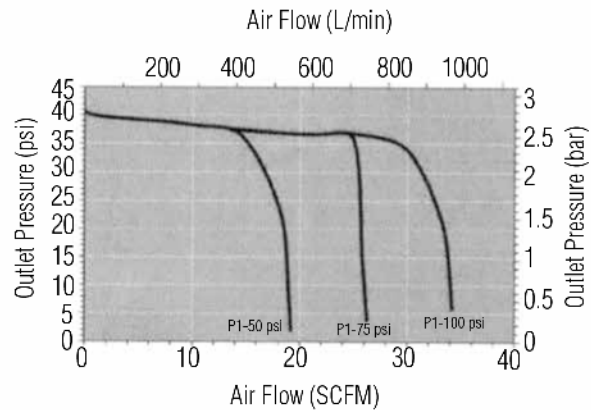

Pressure Control Range

Range Spring: 25-50 psig (1,7-3,4 bar)

Set Point: 45 psig

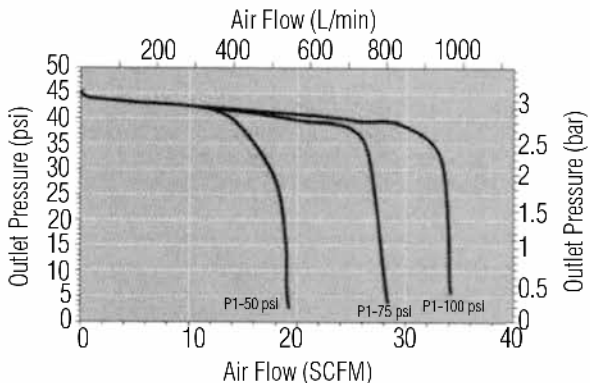

Pressure Control Range

Range Spring: 25-50 psig (1,7-3,4 bar)

Set Point: 50 psig

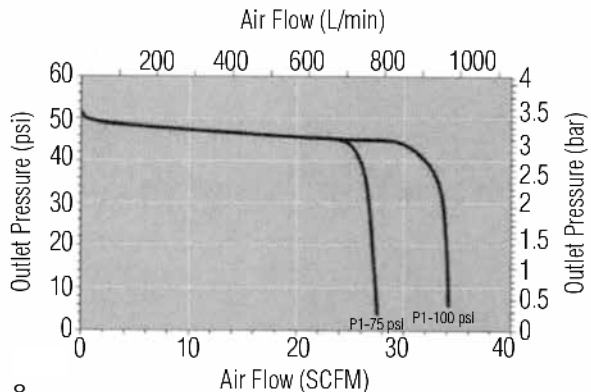

FLOW DATA FOR CV TRIM SELECTION

The graphs illustrate the change or "droop" in outlet pressures as the flow rate increases, and the lockup (setpoint rise) as flow decreases and approaches zero.

Flow Coefficient: 0.8

Maximum inlet pressure: 150 psig (10,3 bar)

Pressure Control Range

Range Spring: 1-5 psig (0-0,3 bar)

Set Point: 1 psig

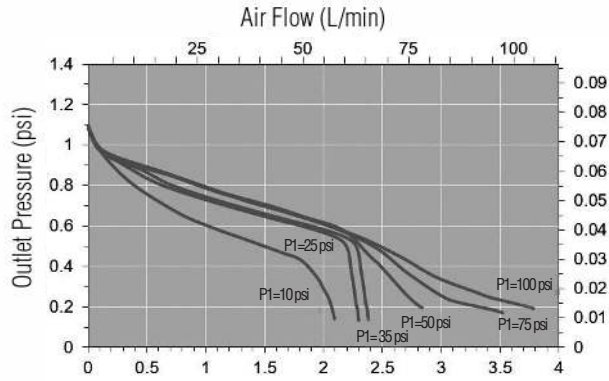

Pressure Control Range

Range Spring: 1-5 psig (0-0,3 bar)

Set Point: 2 psig

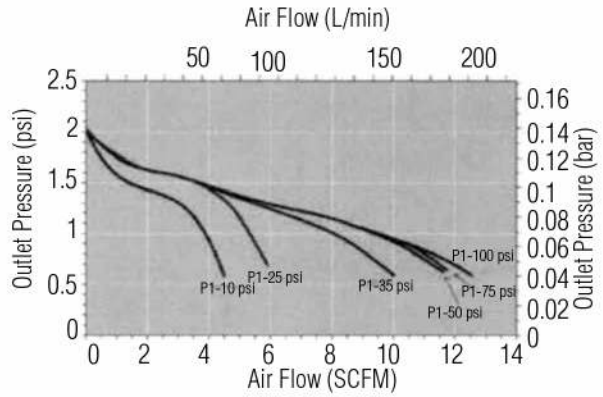

Pressure Control Range

Range Spring: 1-5 psig (0-0,3 bar)

Set Point: 5 psig

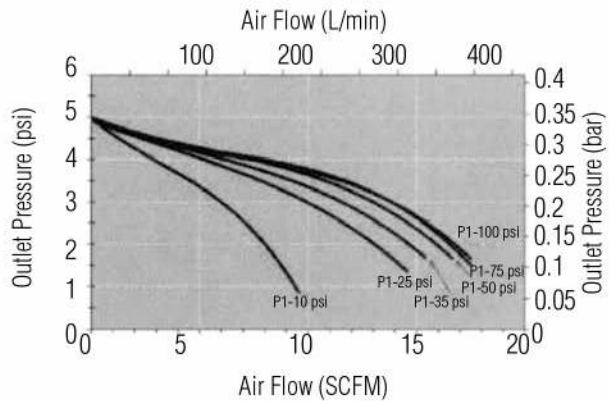

Pressure Control Range

Range Spring: 5-15 psig (0,3-1,0 bar)

Set Point: 10 psig

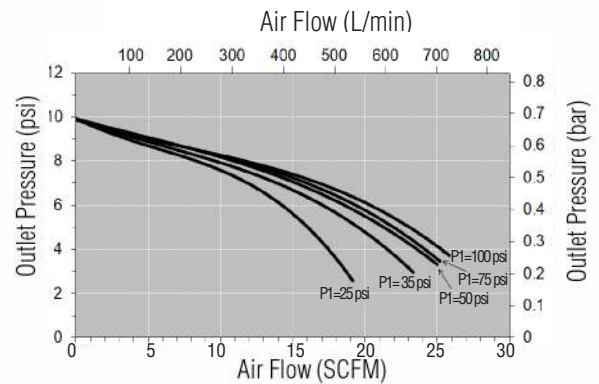

Pressure Control Range

Range Spring: 5-15 psig (0,3-1,0 bar)

Set Point: 15 psig

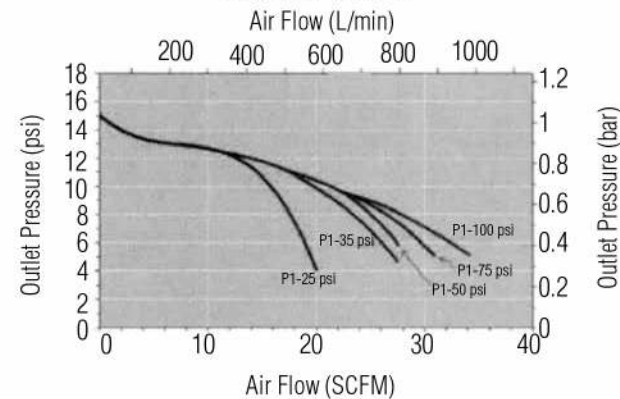

Pressure Control Range

Range Spring: 15-25 psig (1,0-1,7 bar)

Set Point: 20 psig

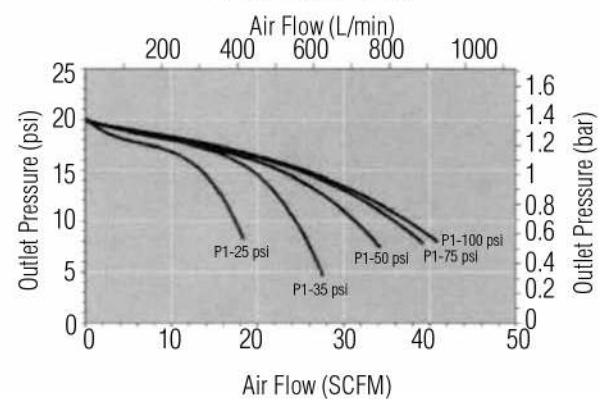

FLOW DATA FOR Cv TRIM SELECTION

The graphs illustrate the change or "droop" in outlet pressures as the flow rate increases, and the lockup (setpoint rise) as flow decreases and approaches zero.

Flow Coefficient: 0.8

Maximum inlet pressure: 150 psig (10,3 bar)

Pressure Control Range

Range Spring: 25-50 psig (1,7-3,4 bar)

Set Point: 25 psig

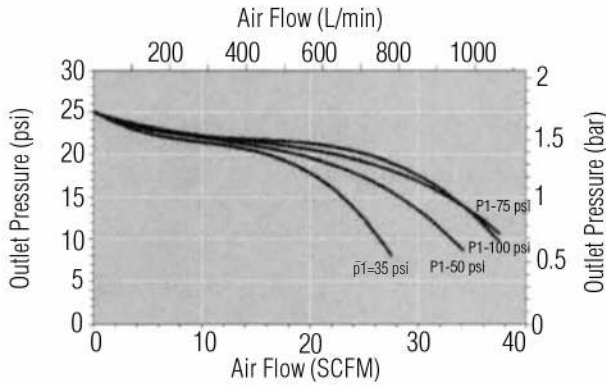

Pressure Control Range

Range Spring: 25-50 psig (1,7-3,4 bar)

Set Point: 30 psig

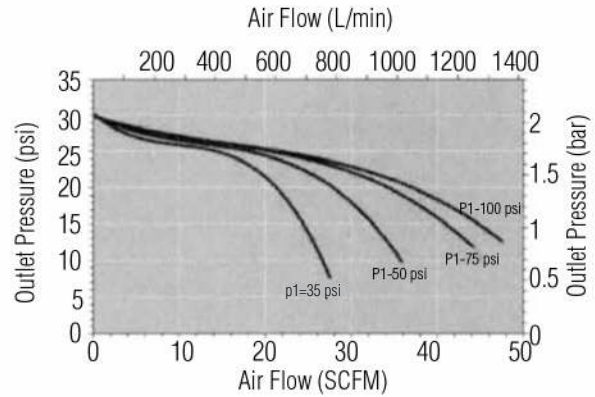

Pressure Control Range

Range Spring: 25-50 psig (1,7-3,4 bar)

Set Point: 35 psig

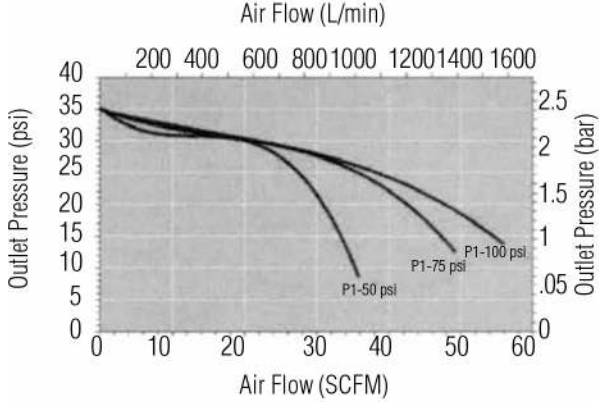

Pressure Control Range

Range Spring: 25-50 psig (1,7-3,4 bar)

Set Point: 40 psig

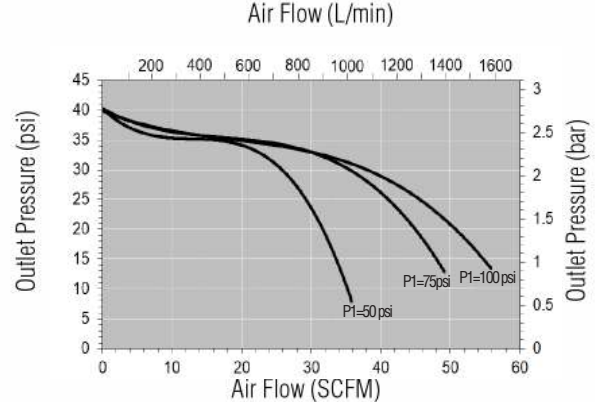

Pressure Control Range

Range Spring: 25-50 psig (1,7-3,4 bar)

Set Point: 45 psig

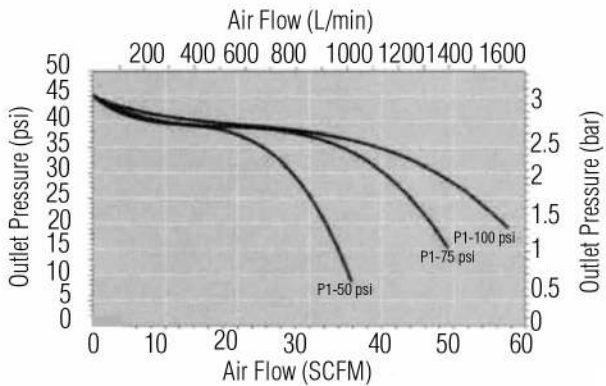

Pressure Control Range

Range Spring: 25-50 psig (1,7-3,4 bar)

Set Point: 50 psig

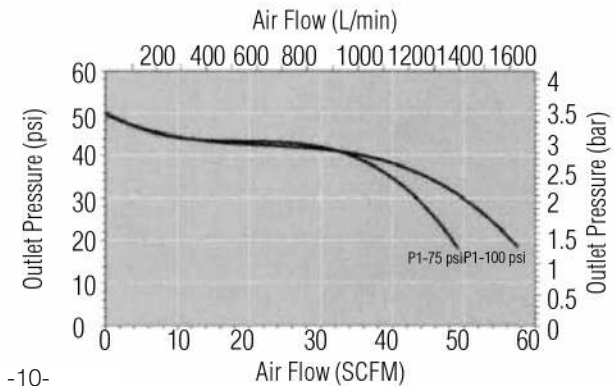

FLOW CONFIGURATIONS/ GAUGE PORTS

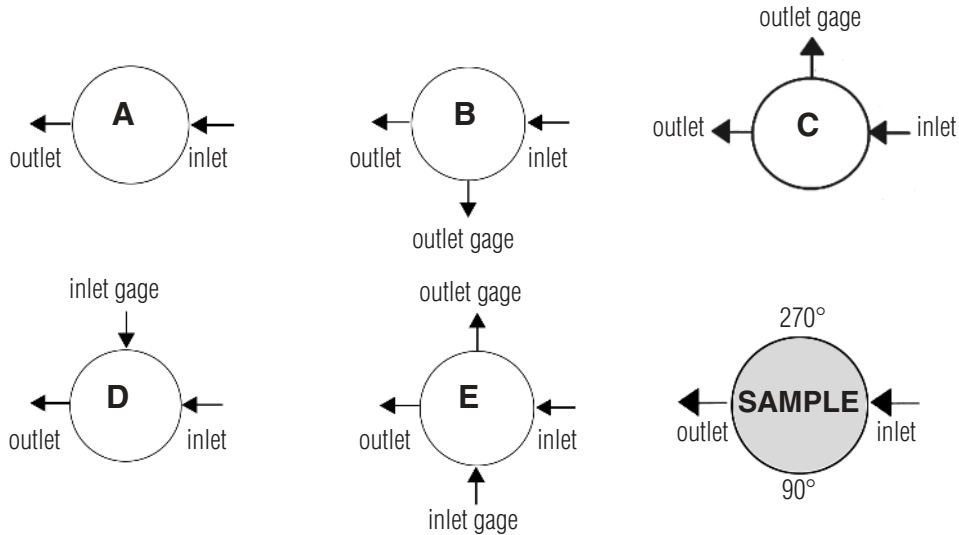

* Gage ports are 1/4" FNPT standard. For Tri-Clamp, VCR and other port options, contact the factory.

SAMPLE SPECIFICATIONS

Stainless Steel pressure regulator shall be made from ASTM A479 barstock material, which includes body and all wetted metal parts. Regulator shall be activated by an un-tied, FDA approved, USP Class VI certified Jorlon diaphragm. Regulator shall be free of exposed threads within wetted process area and valve internal to hold minimal media volume. Regulator shall be direct acting and have a diaphragm area of no less than 18.75" to enable low set point offset. Regulator shall have trim that can be replaced inline without dome/spring chamber disassembly. Regulator shall reliably control outlet pressures as low as 1 psig.

DIMENSIONS, IN. (MM) – 1/2" & 3/4" FOR ASME BPE

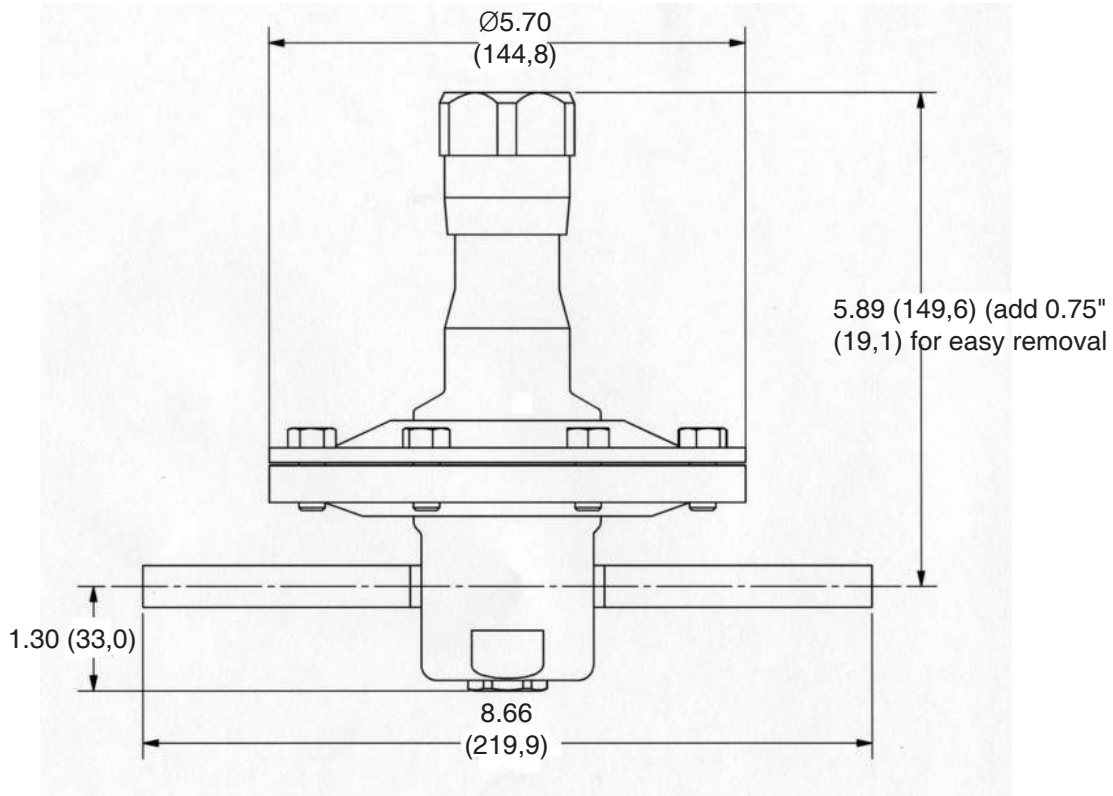

DIMENSIONS, IN. (MM) – 1/2" & 3/4" FOR ASME BPE

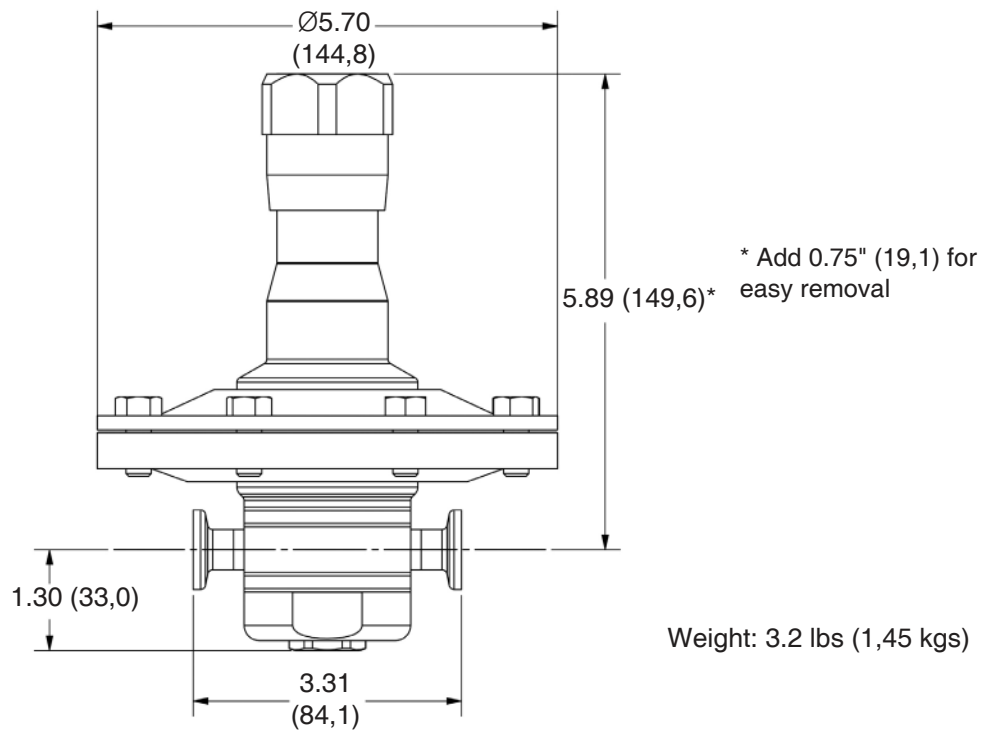

**DIMENSIONS, IN. (MM) – DN15, 20 FOR DIN 32676 Row B (ISO 1127)
AND DIN 32676 Row A (DIN 11850)**

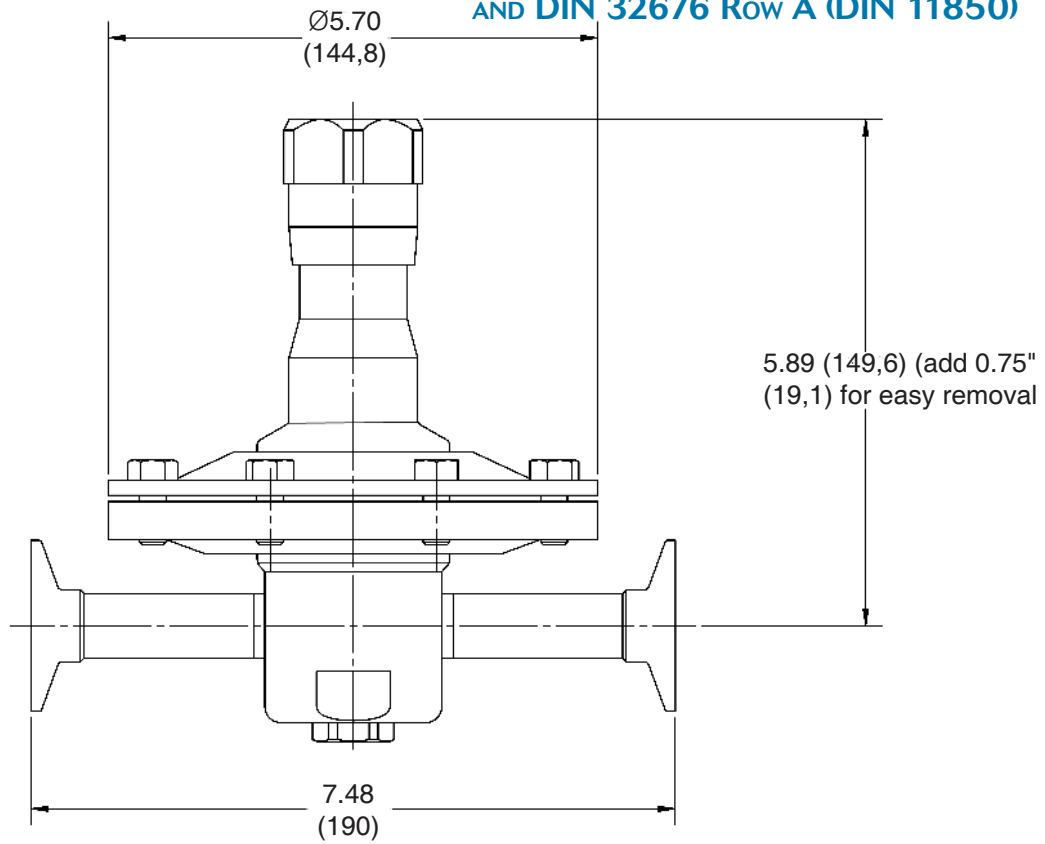

ORDERING SCHEMATIC

Model	Size	Material	1 & 2	3 & 4	5 & 6	7 & 8	9 & 10	11 & 12	13 & 14	15	16	17

Model	
JSRLP	High Purity Gas Pressure Reducing Valve

Size	
050	1/2" (DN15)
075	3/4" (DN 20)

Material	
6L	Stainless Steel 316L

1	Body Feature
End Connection	
ASME BPE Selections	
C	Tri-Clamp 20 Ra EP
P	FNPT 20 Ra EP
T	Tube Weld End 20 Ra EP
ISO Selections	
S ¹	ISO Tri-Clamp, DN15
V ¹	ISO w/34.0mm face T-Clamp, DN15
R ¹	ISO T-Clamp, DN20
H ⁴	ISO Tube Weld, DN15
DIN Selections	
D ²	DIN Tri-Clamp, DN15
N ²	DIN T-Clamp, DN15 w/50.5mm face
U ²	DIN T-Clamp, DN20
X ²	DIN T-Clamp, DN20 w/50.5mm face
M ³	DIN Tube Weld, DN15
ZZ	Non-Standard

2	Body Feature
Port Configuration*	
A	Port "A"
B	Port "B"
C	Port "C"
D	Port "D"
E	Port "E"

* Std. Gauge Ports are 1/4" FNPT. Contact factory for availability of others

5 & 6	Seat Material
TF	PTFE
PK	Peek
EP	EPDM
ZZ	Non-Standard

7 & 8	Range Spring/Outlet Pressure
01	1 - 5 psi
05	5- 15 psi
15	15 - 25 psi
25	25 - 50 psi
ZZ	Non-Standard

9 & 10	Diaphragm Material
JL	Jorlon
ZZ	Non-Standard

11 & 12	Actuator
SK	Standard Actuator
AK	Standard Actuator / Autoclavable Anod. Aluminum knob
PM	Panel Mount (See illustration page 2)
CV ¹	Captured Vent provides fitting on spring housing for venting self-relieved gas
AA ¹	Air Loading provides fitting for air input on spring housing, and a stem seat nut NOTE: You cannot self-relieve and airload at the same time
TP	Anti-tamper feature (See illustration page 5)
ZZ	Non-Standard

¹ Acc. to DIN 32676 Row B (ISO 1127). See dimensions, page 4
² Acc. to DIN 32676 Row A (DIN 11850). See dimensions, page 4
³ Acc. to DIN 11866, DIN 11850 Row A
⁴ Acc. to DIN 11866 Row B, (ISO 1127)

3 & 4	Trim
1S	0.8 Cv
2S	0.5 Cv
1R	CV 0.8 Self-Relieving**
2R	Cv 0.5 Self-Relieving**
ZZ	Non-Standard

** You cannot choose the Self-Relieving option, if using the Air-Loading Option. See Page 3 for complete description.

13 & 14	Inlet Gauge*
AA	0 - 30 PSIG/Bar (Dual)
BB	0 - 60 PSIG/Bar (Dual)
CC	0 - 100 PSIG/Bar (Dual)
DD	0 - 160 PSIG/Bar (Dual)
EE	0 - 200 PSIG/Bar (Dual)
NN	None
ZZ	Non-Standard

* Customer assumes all responsibility for possible damage or injury if selected gauge span does not fully cover range spring / outlet pressure option

ORDERING SCHEMATIC (CON'T)

Model	Size	Material	1 & 2	3 & 4	5 & 6	7 & 8	9 & 10	11 & 12	13 & 14	15	16	17

15	Outlet Gauge*
A	0 - 30 PSIG/Bar (Dual)
B	0 - 60 PSIG/Bar (Dual)
C	0 - 100 PSIG/Bar (Dual)
D	0-160 PSIG/Bar (Dual)
N	None
ZZ	Non-Standard

* Customer assumes all responsibility for possible damage or injury if selected gauge span does not fully cover range spring / outlet pressure option

* Gauges are Oil Free and O2 clean as standard.

16	SEP Compliance
O	None Required
G	SEP Compliant
Z	Non-Standard

17	Accessories
O	None Required
S	Clean For Oil Free
X	Clean for Oxygen ²
J	Clean for Oxygen, Assemble Dry ^{1,2}
A	EN10204 3.1 Cert for Wetted Parts
Z	Non-Standard

¹ Procedure complies with ASTM G-93 2011 and CGA G-4.1-2009

² Use of Oxygen safe lubricant (Krytox™ for example) can affect gas line particulate testing. Assembling all wetted components dry (without lubricant) removes that effect, however it may increase the difficulty in disassembly/reassembly of valve seat components during valve maintenance. Note that we will use O2 safe lubricant on non-wetted threaded components.

REPAIR KIT ORDERING SCHEMATIC

Model	Size	Material	Kit	1&2	3&4

Model	
JSRLP	High Purity Gas Pressure Reducing Valve

Size	
050	1/2"
075	3/4"

Material	
6L	Stainless Steel 316L

Kit	
KT	Repair Kit

1 & 2	Trim/Seat Material
PK	PEEK
TF	PTFE
EP	EPDM
ZZ	Non-Standard

3 & 4	Diaphragm Assembly
R1	Self Relieving / Jorlon / 0.5 Cv
R2	Self Relieving / Jorlon / 0.8 Cv
S1	Standard / Jorlon / 0.5 Cv
S2	Standard / Jorlon / 0.8 Cv
ZZ	Non-Standard

** You cannot choose the Self-Relieving option, if using the Capture Vent option for Air-Loading. See Page 3 for complete description.



Steriflow, a division of Jordan Valve
 3170 Wasson Road • Cincinnati, OH 45209
 513.533.5600 • 800.543.7311 • 513.871.0105 (f)
 steriflow@richardsind.com • www.steriflowvalve.com