

JSRFLP Series

New Options!

- Air Augment Option
- EPDM seat for low lockup and tight shutoff

Pressure Reducing Valves for Low Flow and Low Pressure Biopharmaceutical and Parenteral process Gas

JSRFLP is a high purity low flow, regulator designed and built specifically for very low pressure hygienic, ASME BPE gas applications.

The JSRFLP has been designed specifically for very low pressure clean gas regulation in Stainless and Single Use Disposable applications. Whether it's precise regulation for sparging, blanketing, motive force, or SUD bag inflation, the JSRFLP was built for the job!

The durable valve body and metal trim components are machined from ASTM A479 316L SST barstock and finished to ASME BPE SF5, 20Ra micro-inch, (0.5 Ra micrometer) electropolished as standard.

The valve is outfitted with a sensitive PTFE Jorlon diaphragm and Teflon, PEEK and EPDM seats and seals that are all FDA approved, USP Class VI compliant materials. These materials of construction enable JSRFLP to withstand the rigors of an autoclave if required.

FEATURES

- Stable outlet pressure setpoints at very low pressure
- Very low set point offset (droop) especially at higher inlet pressures
- Top entry design facilitates in-line cleaning and maintenance
- Barstock construction guarantees material integrity and quality surface finish
- Four Cv's from 0.01 to 0.2 guarantee a valve that will fit your specific application
- Optimized internal volume
- Proprietary Jorlon diaphragm material provides exceptionally long life
- Soft seat material for ANSI Class VI shutoff

DOCUMENTATION

The following documentation is shipped at no charge:

- Steriflow Unicert, a QC signed Certificate of Compliance for:
 - Material, listing heat numbers with attached MTR's
 - Surface Finish
 - FDA/USP Class VI - for all thermoplastic and elastomers
- Traceability:
 - Each individual product serial number is traceable to the Unicert serial number, heat numbers and attached MTR's

Other documents must be requested at time of RFQ, or order:

- ADI/TSE Free, Certified Test reports, Certificate of Origin.



APPLICATIONS

The JSRFLP is a Pressure Regulating valve ideal for low flow, low pressure precision regulation of clean compressed air and gas used in pharmaceutical and biopharmaceutical R&D, Pilot, and Production facilities.

It is designed specifically for use on traditional Stainless Steel and Single Use Disposable applications including:

- Small sterile vessels:
 - Gas overlay (blanketing)
 - Sparging
 - SUD bag integrity testing/inflation
- Incubators
- Lyophilizers
- Time/pres filling machine product hold vessels

Suitable for clean compressed gas, including:

- Air
- Nitrogen
- Carbon Dioxide
- Oxygen
- Argon
- Custom gas mixtures

SPECIFICATIONS

Sizes: 1/4" (DN8), 3/8" (DN10), 1/2" (DN15)

End Connections: ASME BPE, DIN, ISO Tri-clamp, or Tube Weld end; NPT

Gauge Ports: 1/4" FNPT is standard. Contact Factory for Tri-Clamp, VCR, or other alternatives.

Soft Seat Materials for ANSI Class VI Shut-off

- PTFE to +252°F (122°C) continuous or 275°F (135°C) intermittent [not to exceed 15 min. in a one hour period] FDA, USP Class VI
- PEEK to +350°F (177°C), FDA & USP Class VI
- EPDM to +275°F (135°C), FDA & USP Class VI

Body and Trim Material

- ASME SA479 316L (UNS 31603) is standard. EN 10272:2000 GR 1.4435, AL-6XN®, Hastelloy®C-22 and others are optional.

Diaphragm Material: Jorlon - PTFE™, FDA & USP Class VI

Maximum Inlet Pressure:

- Tube End & Tri-Clamp: 150 psig (10,3 bar)
- NPT: 150 psig (10,3 bar)

Optional Cleaning Specifications

- Clean for Oil-Free
- O2 Cleaning complying with ASTM G93-03 2011 and CGA G-4.1-2009

Pressure at Maximum Temperature:

- Tube End and Tri-Clamp: 150 psi @ 350°F (10,3 bar @ 177°C) with PEEK seats; 150 psi @ 150°F (10,3 bar @ 66°C) with PTFE seats; 150 psi @ 275°F (10,3 bar @ 135°C) with EPDM seats
- NPT: 150 psi @ 350°F (10,3 bar @ 177°C) with PEEK seats; 150 psi @ 150°F (10,3 bar @ 66°C) with PTFE seats; 150 psi @ 275°F (10,3 bar @ 135°C) with EPDM seats

Surface Finish:

- Wetted Internal surface finish: Mechanically polished, and electropolished to ASME BPE SF5, 20 Ra μin (0.5 Ra μm) as standard
- Exterior surface finish: Mechanically polished to 40 Ra μin (1.0 Ra μm) as standard
- Other finishes available upon request

Maximum Pressure Drop:

- Tube End and Tri-Clamp: 150 psi (10,3 bar)
- NPT: 150 psi (10,3 bar)

Spring Ranges: 1 – 75 psi (0,07 – 5,2 bar), 25 - 100 psi (1,7 - 6,9 bar)

Flow Capacities: Cv 0.012, Cv 0.03, Cv 0.08, Cv 0.20 (Kv 0,010, Kv 0,026, Kv 0,069, Kv 0,173)

Options

- Oxygen cleaning and certification
- Panel Mounting
- Captured Vent
- Self Relieving
- Gauge Ports, Pressure Gauges
- Air Augment

Note: For a complete ancillary list of all wetted and un-wetted material specifications, please contact Steriflow Valve.

OPTION DEFINITION

Captured Venting

The captured vent option provides a means to vent downstream, self-relieved gas. To enable this function, a 1/8" FNPT collar is installed on the spring housing. This feature provides a means to safely transport toxic or hazardous, self-relieved downstream gas away from the spring housing via tubing to a safe area.

!VIP! This option must be specified with the Self-Relieving* option if the user wishes to transport self-relieved vented gas to a safe location.

Air Augment

The air augment option provides a means for air loading the valve spring housing for automated control. To enable this function a 1/8" FNPT collar is installed on the spring housing (the same one used for the captured vent option), and a Teflon seal nut is included to seal the adjusting screw threads to prevent leakage. The 1/8" FNPT port is used as the input fitting for loading the spring housing with instrument air to completely automate or augment manual regulator control. An I/P transducer, or a small, self-relieving air set PRV regulator is required (ordered separately) to regulate the instrument air pressure.

***Self-Relieving**

The self-relieving option provides an internal mechanism to vent downstream pressure increase (above the set-point) through the spring housing and out a vent hole in the spring housing. If the gas is toxic, or dangerous - the Captured-Vent option (above) must also be specified. The Self-Relieving option allows for immediate pressure reduction when reducing the set point, provides a means to automatically relieve downstream pressure build-up when flow stops and the valve starts to close (sometimes called Lock-up), and alleviates pressure equalization across the orifice when the regulator is not operating.

!VIP! If selecting the Self-relieving option for a Toxic or Hazardous gas - the Captured Vent option must be selected. You cannot Air-Load if the Self-Relieving option is specified.

Panel Mount

The panel mounted regulator option illustrated on the next page requires a panel cut out of 1-1/2". When this option is specified, the regulator comes fitted with a threaded spring housing, and a panel mounting ring to secure the regulator to the panel.

Gauge Ports - Pressure Gauge

For inlet and outlet pressure gauges (and the gauges) are available as standard options

OPTION ILLUSTRATIONS

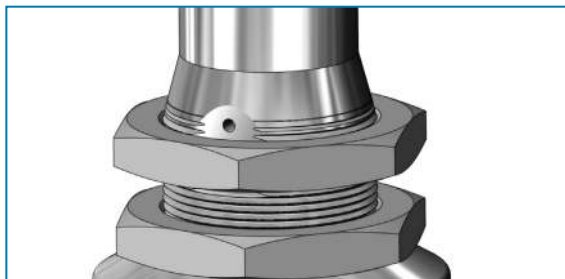

Panel Mount Option

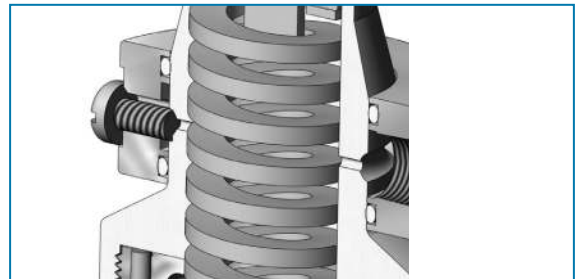

Captured Vent Option (1/8" NPT)

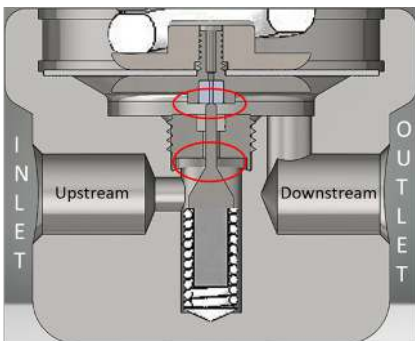

Figure 1: Self Relieving Valve in Closed Position when P2 = set point and flow stops

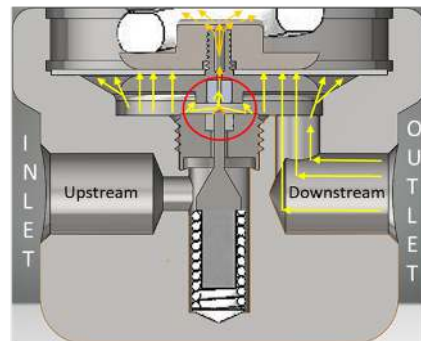
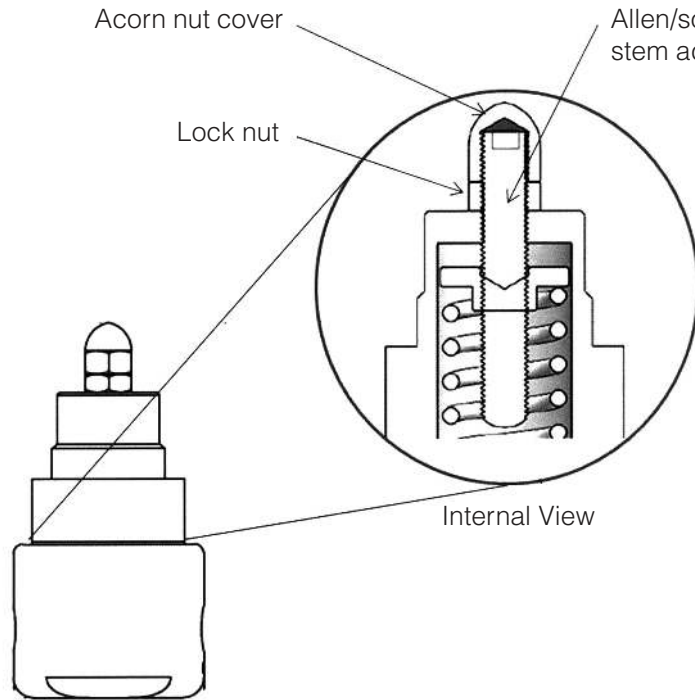

Figure 2: Self Relieving Valve in Closed Position when flow stops and P2 > set point. Showing overpressure release.

Self-Relieving Option

ANTI-TAMPER OPTION



1. Adjust stem position with Allen wrench
2. Tighten lock nut against bonnet while holding stem position
3. Replace and tighten acorn nut

DIN & ISO TRI-CLAMP DIMENSIONS

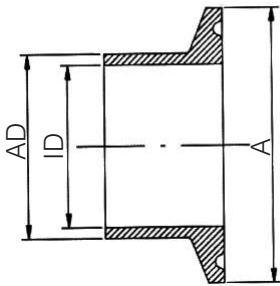

DIN 32676 Row B (ISO 1127)

VALVE SIZE	A	AD	ID
DN15	50.5	21.3	18.1
DN15*	34.0	21.3	18.1
DN20	50.5	26.9	23.7

* with non-standard Tri-clamp face

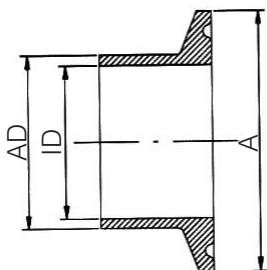

DIN 32676 Row A (DIN 11850)

VALVE SIZE	A	AD	ID
DN15	34.0	19.0	16.0
DN15*	50.5	19.0	16.0
DN20	34.0	23.0	20.0
DN20*	50.5	23.0	20.0

* with non-standard Tri-clamp face

FEATURES & BENEFITS

Reliable, gas pressure regulation at flows less than 1 LPM and set points to 1 psig (69 millibar)

Autoclavable Anodized Aluminum Knob available as cataloged option

Fine thread pitch for precision setpoint adjustments.

ASTM A479 316L body, diaphragm casing, bonnet, and trim

PTFE-Jorlon™ FDA / USP Class VI approved Unsurpassed life

ASME BPE SF5, 20 Ra μin (0,5 Ra μm) electropolish finish is standard

Large diaphragm area for increased stability, and less offset at very low setpoints

FDA / USP Class VI seat material for ANSI Class VI shutoff

1/2" Tri-Clamp and Tube Weld Connections; 1/4", 3/8" and 1/2" NPT

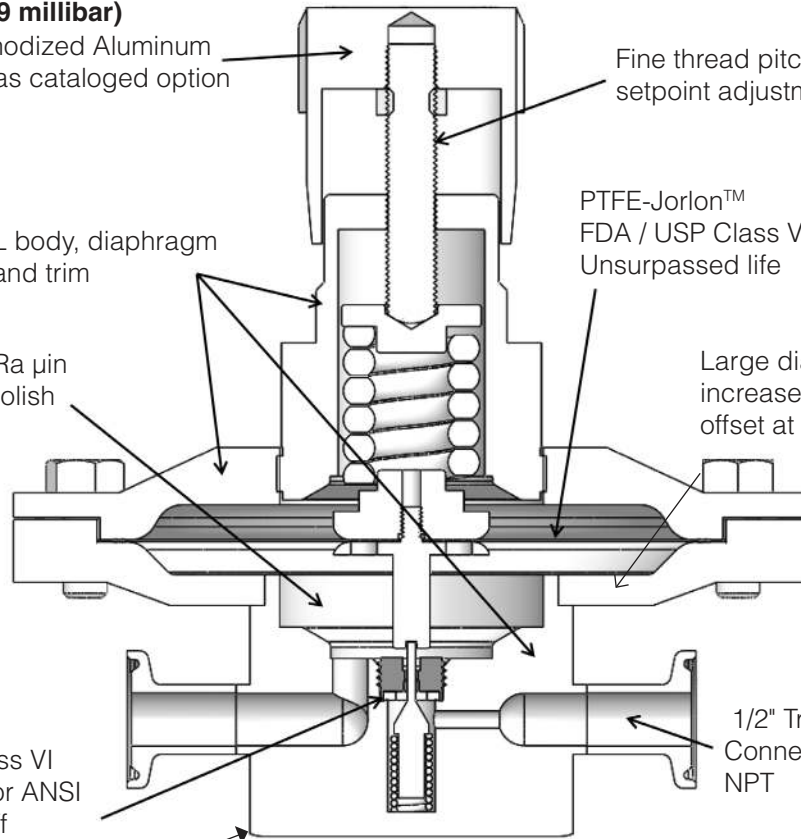

NOTE: Can be used on clean steam or non-cavitating liquids (the design is not drainable) with Steriflow engineering application approval.

FLOW CONFIGURATIONS/ GAUGE PORTS

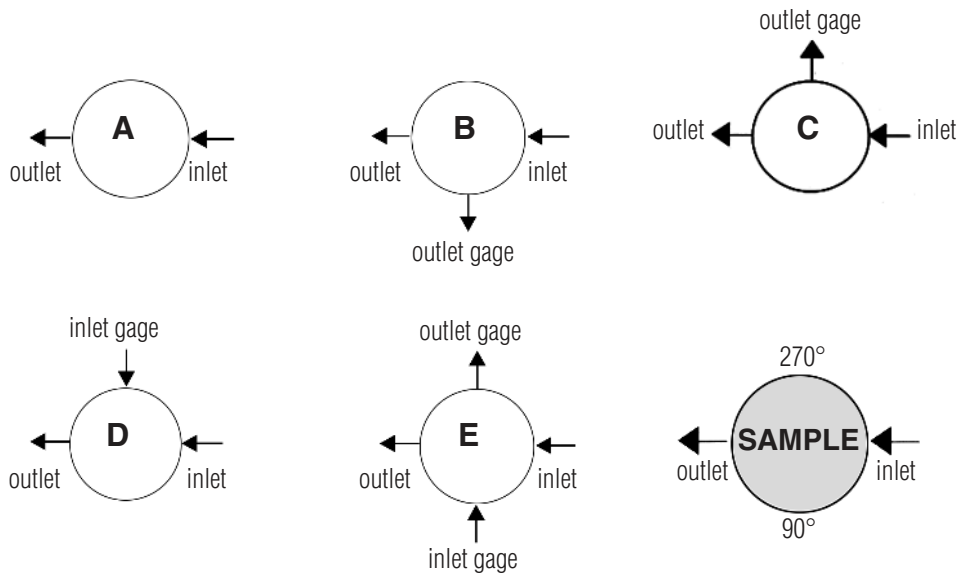

* Gauge ports are 1/4" FNPT as standard. Consult factory for Tri-Clamp, VCR, or other port options.

JSRFLP SERIES LOW FLOW LOW PRESSURE REDUCING VALVE

DIMENSIONS

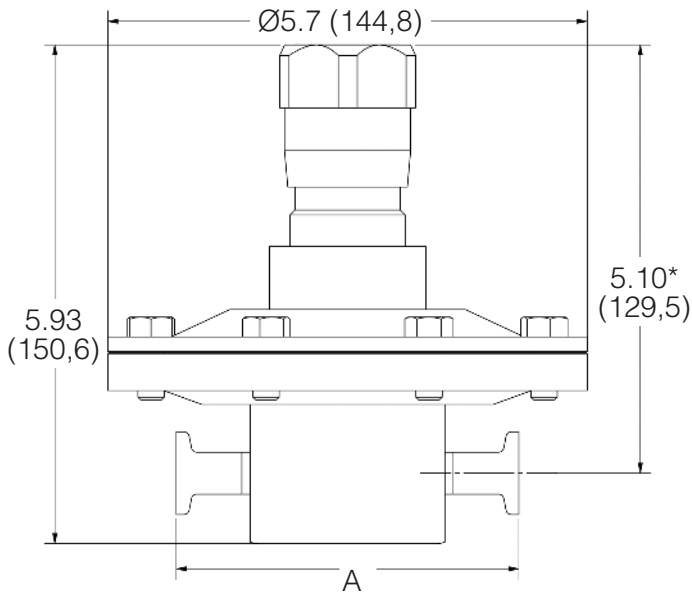

*Add 0.75" (19,1) for easy removal

- JSRFLP Series with ASME BPE Tri-Clamp Ends, Inches (Metric)

VALVE SIZE	A
1/2" (DN15)	4.07 (103,4)
3/4" (DN20)	4.07 (103,4)

- JSRFLP Series with ASME BPE Tube Ends, Inches (Metric)

VALVE SIZE	A
1/2" (DN15)	8.85 (224,8)
3/4" (DN20)	8.85 (224,8)

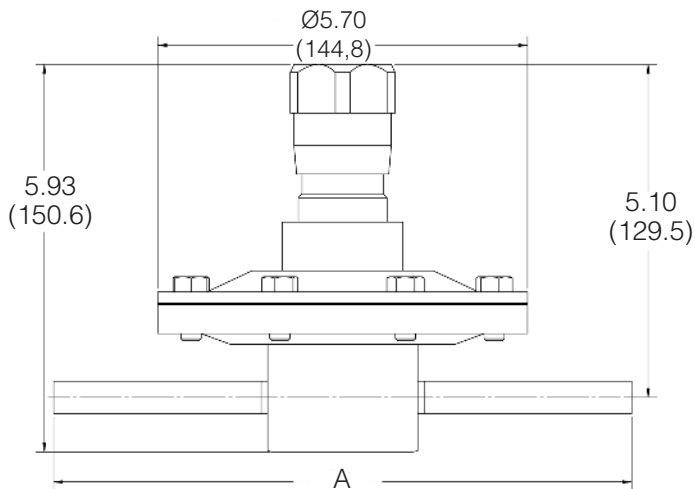

- JSRFLP Series with FNPT/SW Ends, Inches (Metric)

VALVE SIZE	A
1/4" (DN8)	2.00 (50,8)
3/8" (DN10)	2.00 (50,8)
1/2" (DN15)	2.75 (69,9)

**DIMENSIONS, IN (MM)- DN15,20 FOR DIN 32676 Row B (ISO 1127)
AND DIN 32676 Row A (ISO 11850)**

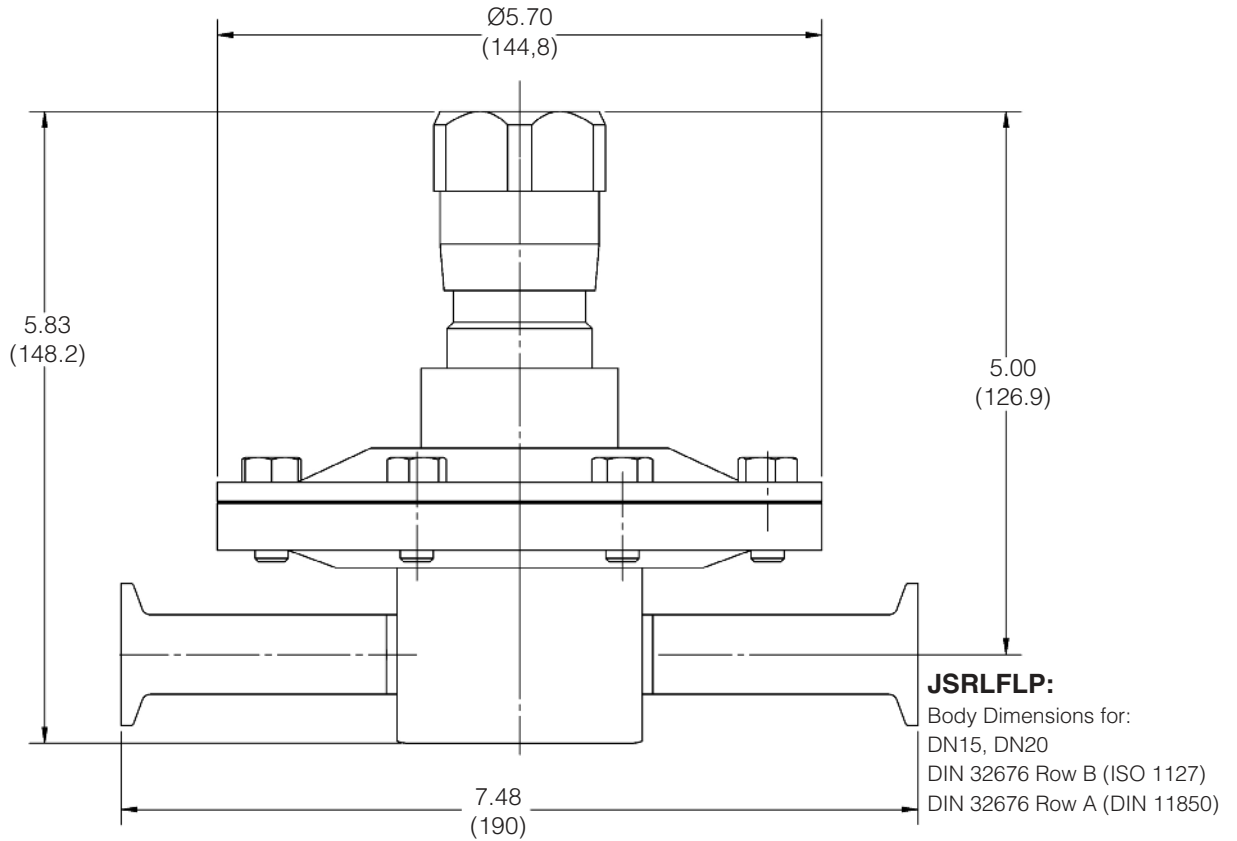

Cv TRIM SELECTION INSTRUCTIONS

To select a valve with the proper Cv:

1. Select a graph on the following thirteen pages that best represents your outlet pressure set point and flow range
2. Looking at that graph, select the closest inlet pressure line (horizontal sloped line, P1) that best reflects your application's actual inlet pressure. That line indicates the Pressure/Flow capabilities and offset (droop) of the trim (Flow Coefficient, Cv) under flowing conditions.
Note: If your exact outlet pressure set point or inlet pressure is not listed you will have to interpolate.
 - Your particular inlet pressure line will be very similar in length and slope to the line chosen on any particular graph.
 - The same is true for your outlet pressure set point, simply shift the line up or down.
3. The Cv is listed in bold at the upper left of the page of your chosen graph. You will need that for model number selection (See page 21).

GAS CONVERSION FACTORS

To convert gas flow rates to the air flow rates shown in the following graphs, multiply the gas flows by the conversion factor listed below.

For example: to convert an Argon flow range of 0.17 to 1.7 LPM to equivalent air flow rates that you can use with the graphs below, multiply each Argon flow rate by 1.18. The air flow range equivalent would be: (0.17 LPM Argon x 1.18) to (1.7 LPM Argon x 1.18), or 0.2 LPM Air to 2.0 LPM air.

Argon 1.18
Carbon Dioxide 1.23
Nitrogen 0.98
Oxygen 1.05

FLOW DATA FOR Cv TRIM SELECTION

The graphs illustrate the change or "droop" in outlet pressures as the flow rate increases, and the lockup (setpoint rise) as flow decreases and approaches zero.

Flow Coefficient: 0.012

Maximum inlet pressure: 150 psig (10,3 bar)

Pressure Control Range

Range Spring: 0-75 psig (0-5,2 bar)

Set Point: 1 psig

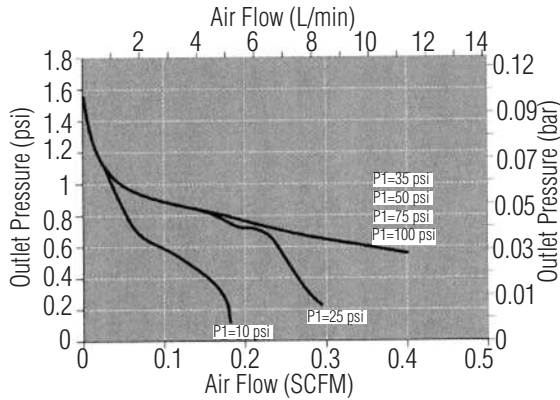

Pressure Control Range

Range Spring: 0-75 psig (0-5,2 bar)

Set Point: 2 psig

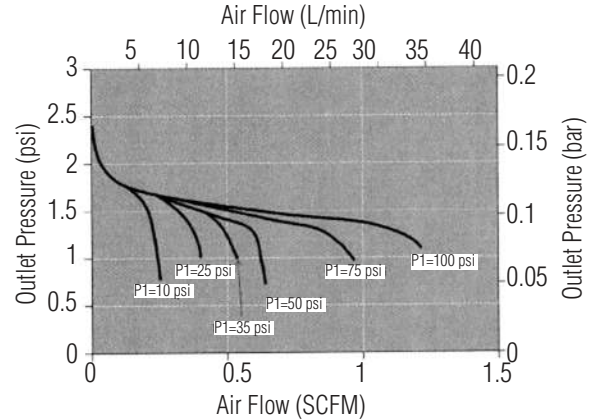

Pressure Control Range

Range Spring: 0-75 psig (0-5,2 bar)

Set Point: 5 psig

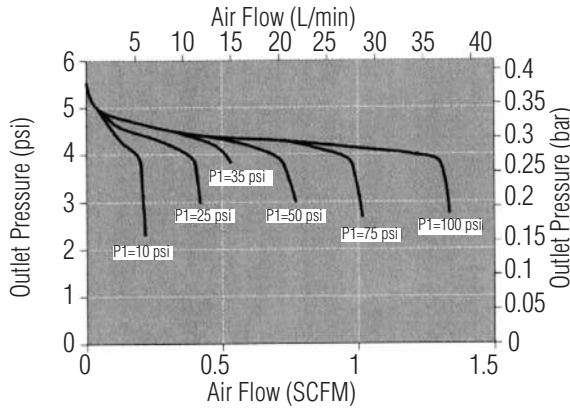

Pressure Control Range

Range Spring: 0-75 psig (0-5,2 bar)

Set Point: 10 psig

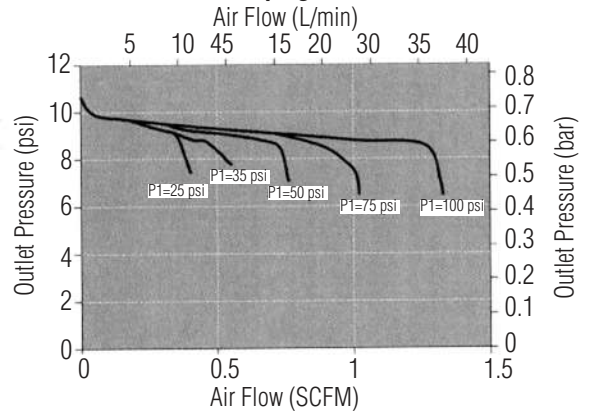

Pressure Control Range

Range Spring: 0-75 psig (0-5,2 bar)

Set Point: 15 psig

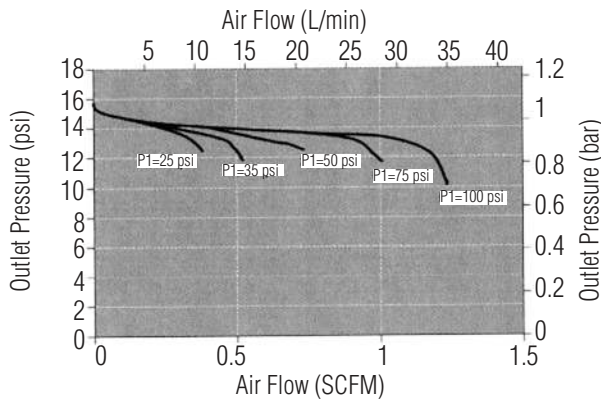

Pressure Control Range

Range Spring: 0-75 psig (0-5,2 bar)

Set Point: 20 psig

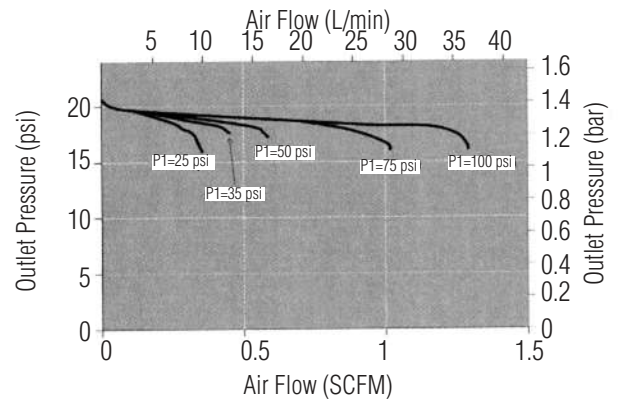

FLOW DATA FOR CV TRIM SELECTION

The graphs illustrate the change or "droop" in outlet pressures as the flow rate increases, and the lockup (setpoint rise) as flow decreases and approaches zero.

Flow Coefficient: 0.012

Maximum inlet pressure: 150 psig (10,3 bar)

Pressure Control Range

Range Spring: 0-75 psig (0-5,2 bar)

Set Point: 25 psig

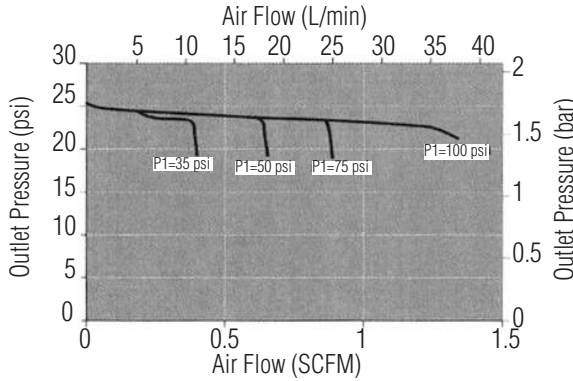

Pressure Control Range

Range Spring: 0-75 psig (0-5,2 bar)

Set Point: 30 psig

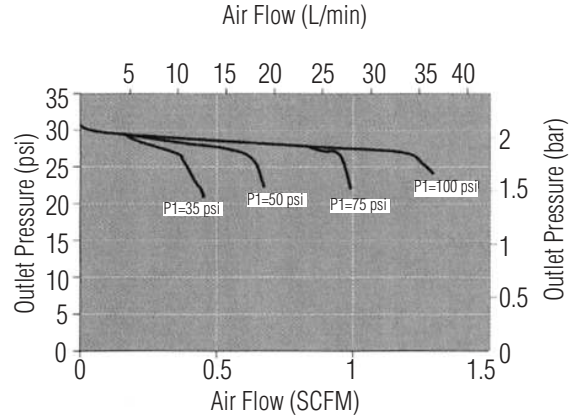

Pressure Control Range

Range Spring: 0-75 psig (0-5,2 bar)

Set Point: 35 psig

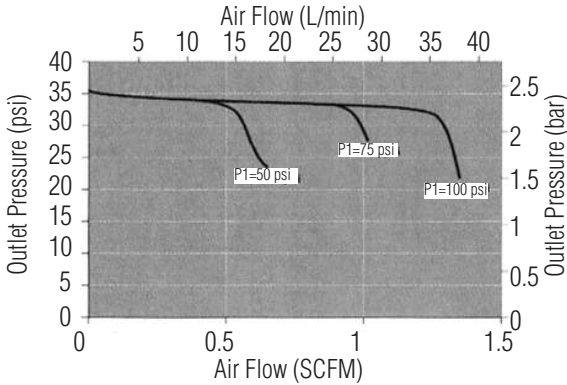

Pressure Control Range

Range Spring: 0-75 psig (0-5,2 bar)

Set Point: 40 psig

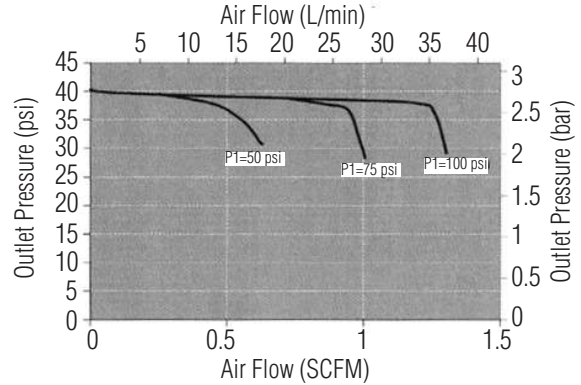

Pressure Control Range

Range Spring: 0-75 psig (0-5,2 bar)

Set Point: 45 psig

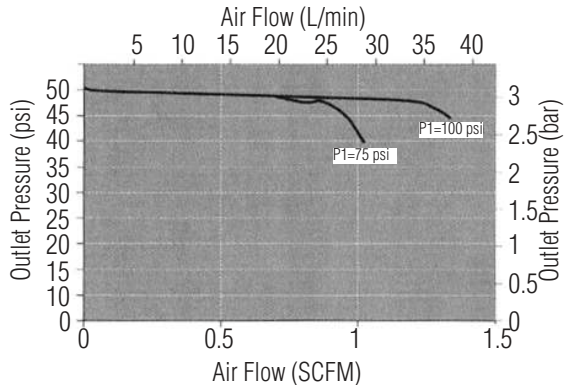

Pressure Control Range

Range Spring: 0-75 psig (0-5,2 bar)

Set Point: 50 psig

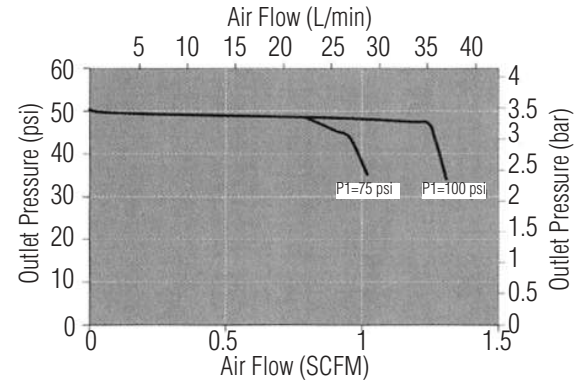

FLOW DATA FOR CV TRIM SELECTION

The graphs illustrate the change or "droop" in outlet pressures as the flow rate increases, and the lockup (setpoint rise) as flow decreases and approaches zero.

Flow Coefficient: 0.012

Maximum inlet pressure: 150 psig (10,3 bar)

Pressure Control Range

Range Spring: 0-75 psig (0-5,2 bar)

Set Point: 55 psig

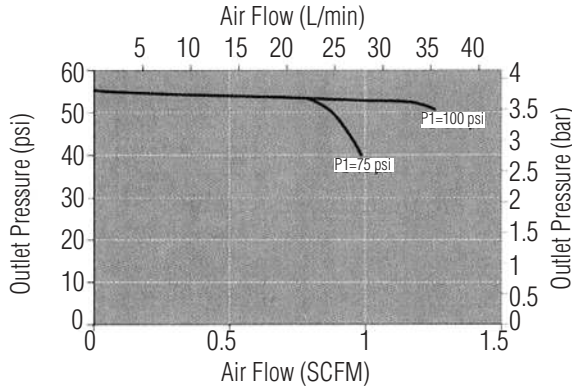

Pressure Control Range

Range Spring: 0-75 psig (0-5,2 bar)

Set Point: 60 psig

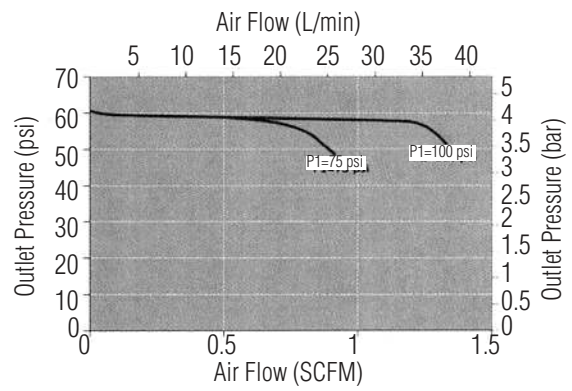

Pressure Control Range

Range Spring: 0-75 psig (0-5,2 bar)

Set Point: 65 psig

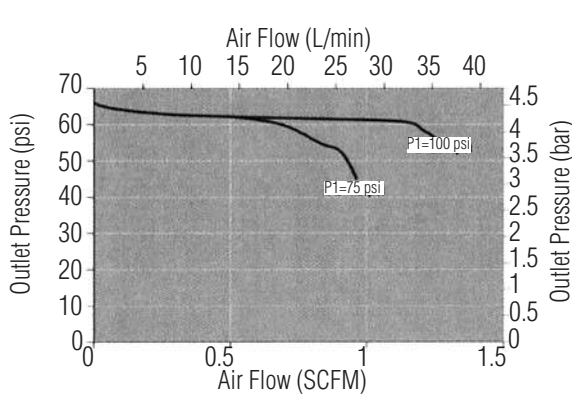

Pressure Control Range

Range Spring: 0-75 psig (0-5,2 bar)

Set Point: 70 psig

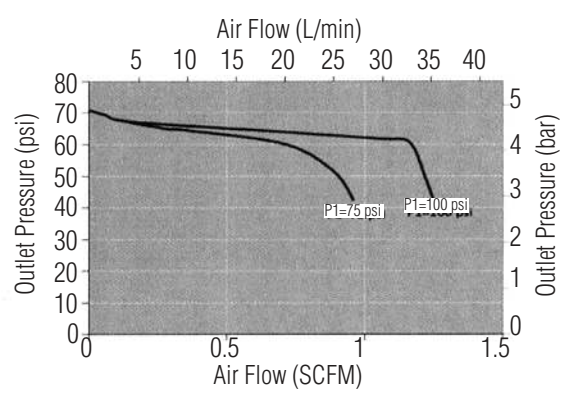

Pressure Control Range

Range Spring: 0-75 psig (0-5,2 bar)

Set Point: 75 psig

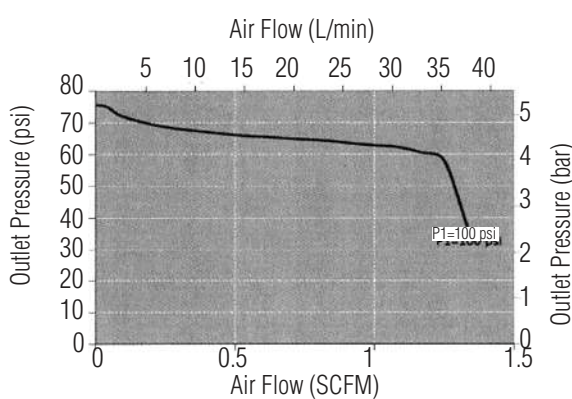

FLOW DATA FOR CV TRIM SELECTION

The graphs illustrate the change or "droop" in outlet pressures as the flow rate increases, and the lockup (setpoint rise) as flow decreases and approaches zero.

Flow Coefficient: 0.03

Maximum inlet pressure: 150 psig (10,3 bar)

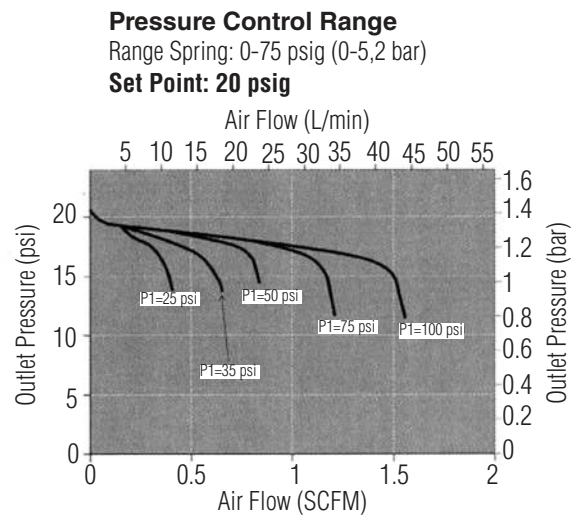
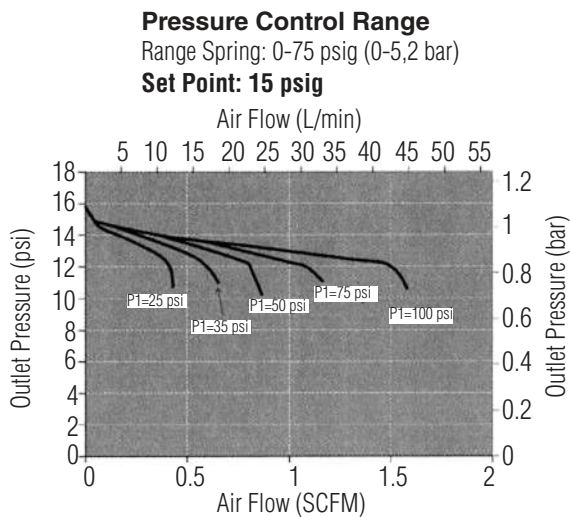
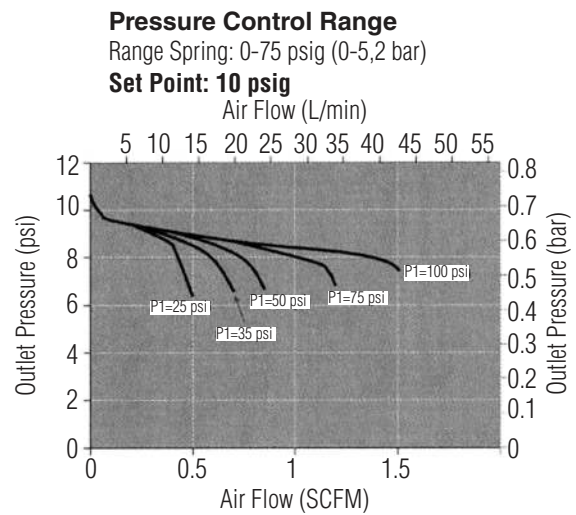
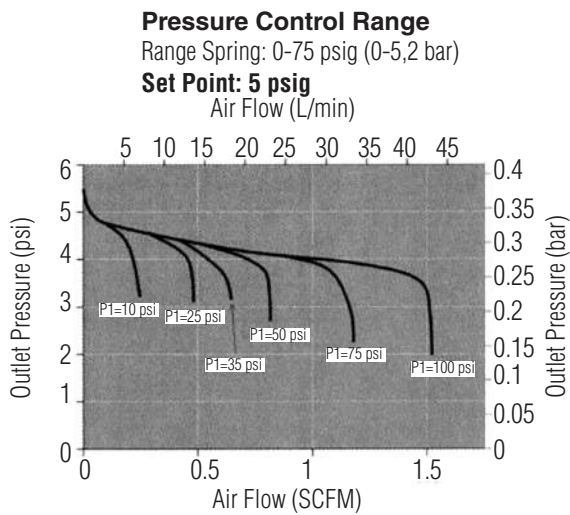
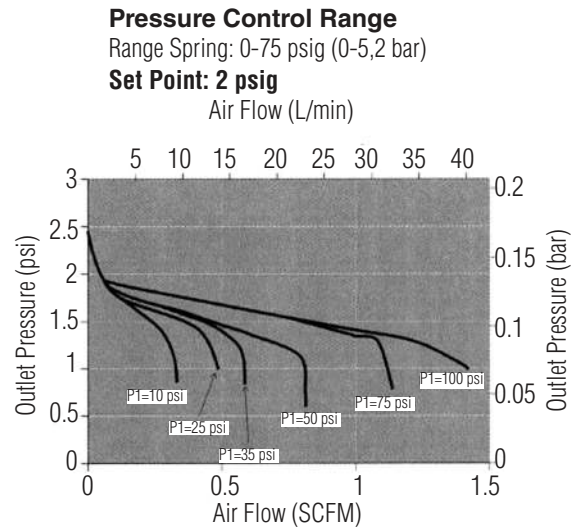
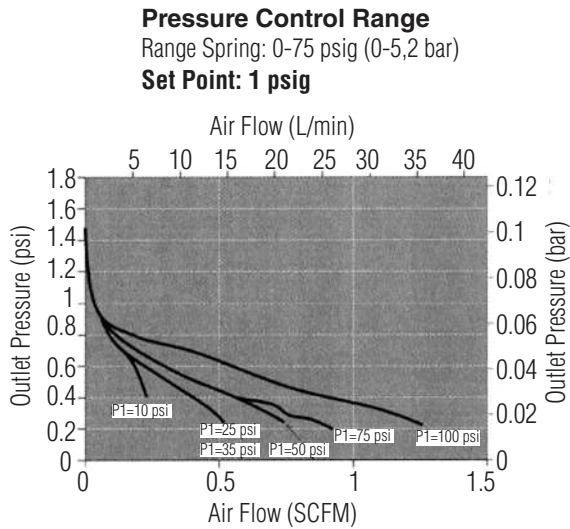

FLOW DATA FOR CV TRIM SELECTION

The graphs illustrate the change or "droop" in outlet pressures as the flow rate increases, and the lockup (setpoint rise) as flow decreases and approaches zero.

Flow Coefficient: 0.03

Maximum inlet pressure: 150 psig (10,3 bar)

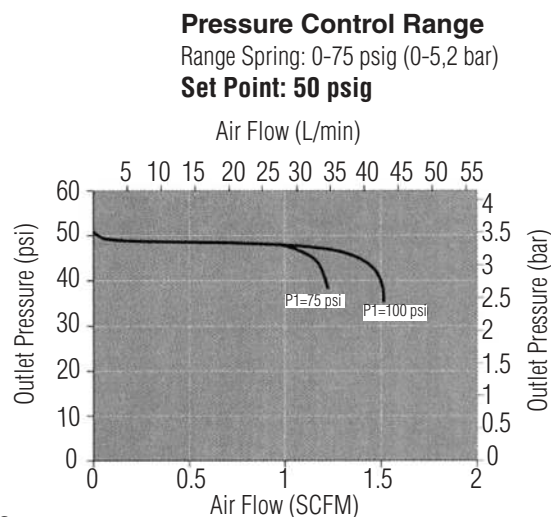
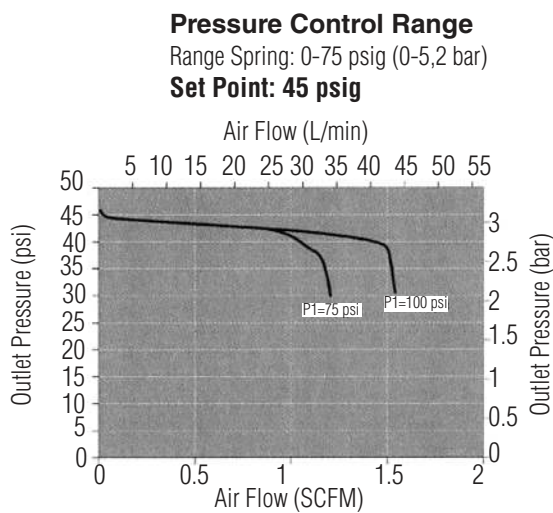
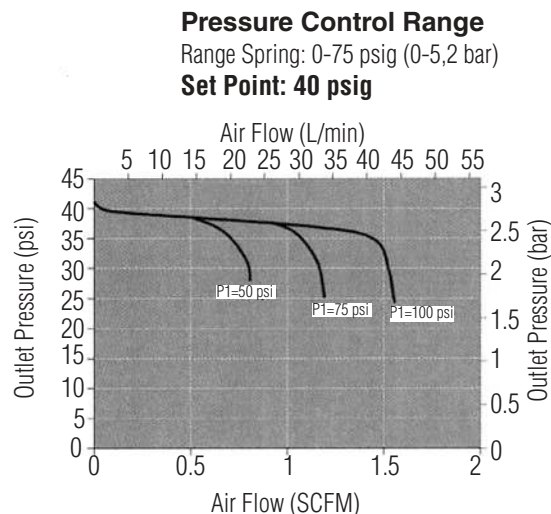
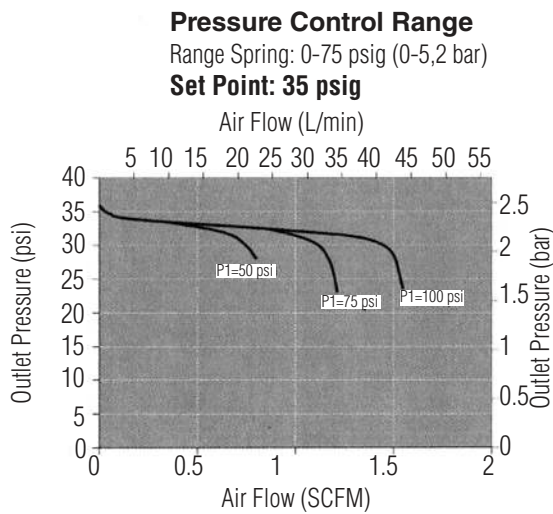
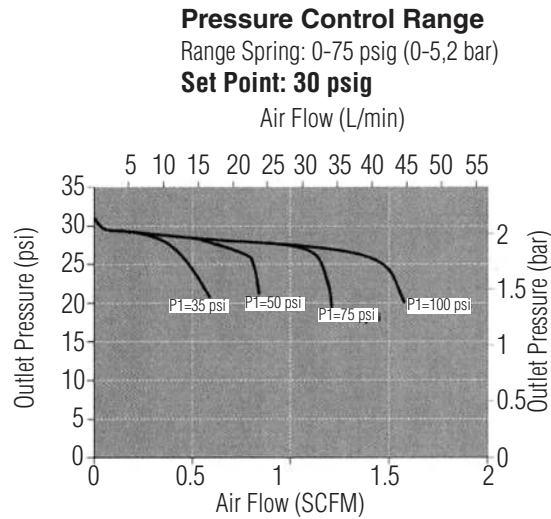
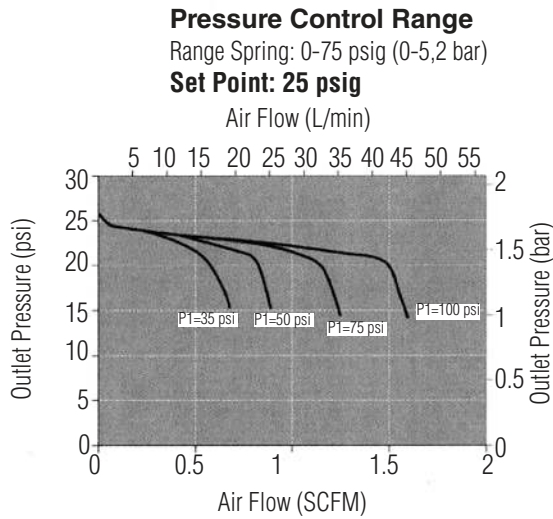

FLOW DATA FOR CV TRIM SELECTION

The graphs illustrate the change or "droop" in outlet pressures as the flow rate increases, and the lockup (setpoint rise) as flow decreases and approaches zero.

Flow Coefficient: 0.03

Maximum inlet pressure: 150 psig (10,3 bar)

Pressure Control Range

Range Spring: 0-75 psig (0-5,2 bar)

Set Point: 55 psig

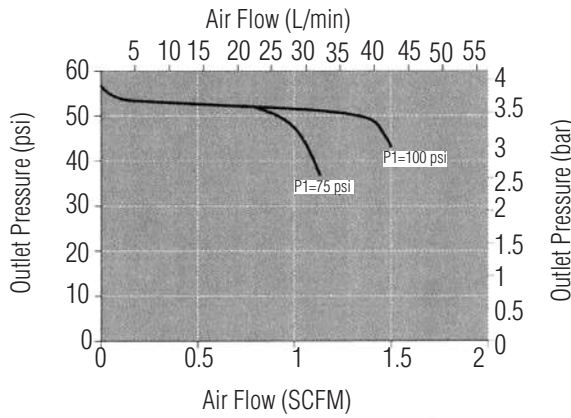

Pressure Control Range

Range Spring: 0-75 psig (0-5,2 bar)

Set Point: 60 psig

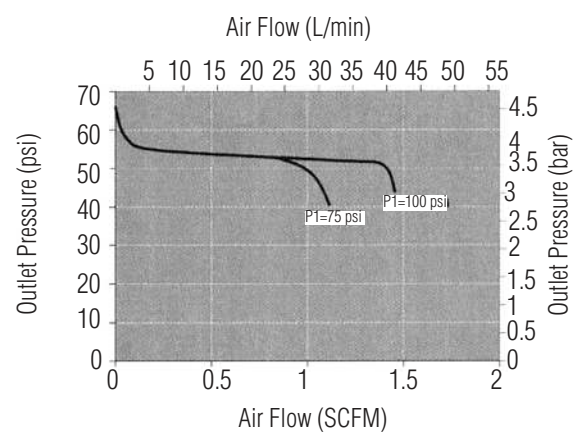

Pressure Control Range

Range Spring: 0-75 psig (0-5,2 bar)

Set Point: 65 psig

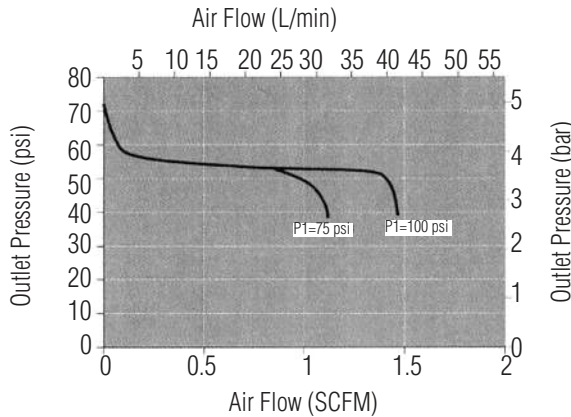

Pressure Control Range

Range Spring: 0-75 psig (0-5,2 bar)

Set Point: 70 psig

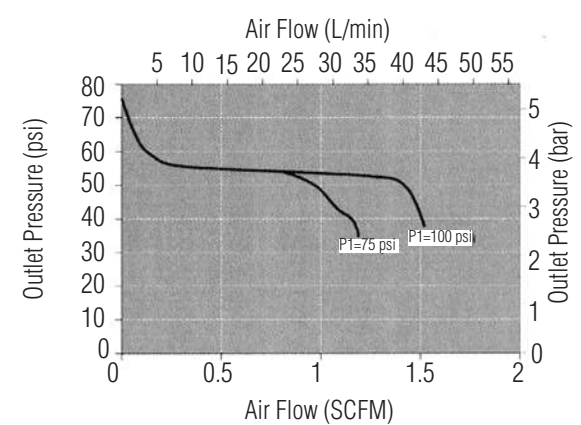

Pressure Control Range

Range Spring: 0-75 psig (0-5,2 bar)

Set Point: 75 psig

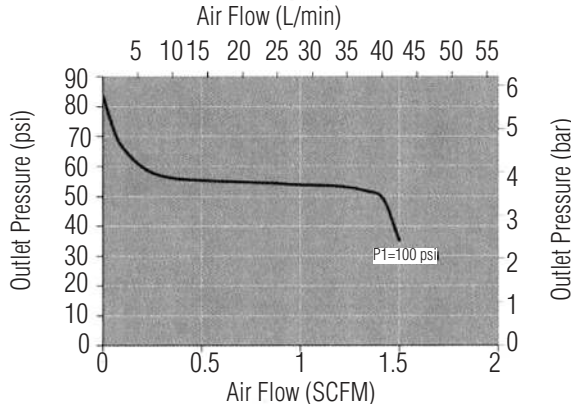

FLOW DATA FOR CV TRIM SELECTION

The graphs illustrate the change or "droop" in outlet pressures as the flow rate increases, and the lockup (setpoint rise) as flow decreases and approaches zero.

Flow Coefficient: 0.08

Maximum inlet pressure: 150 psig (10,3 bar)

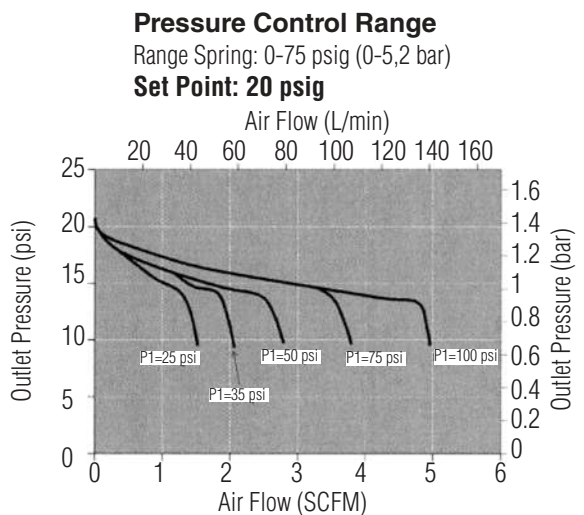
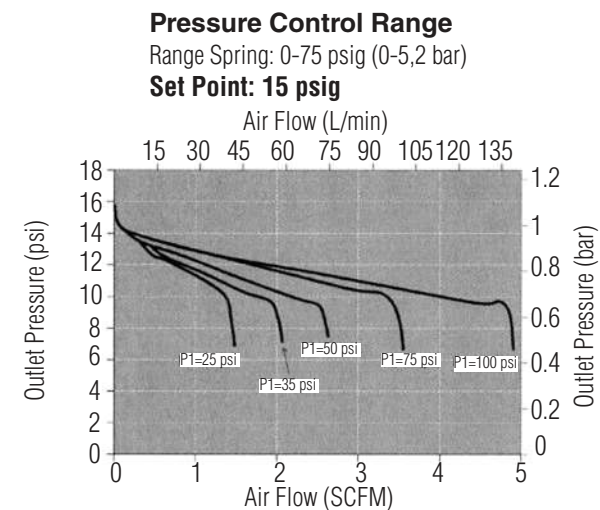
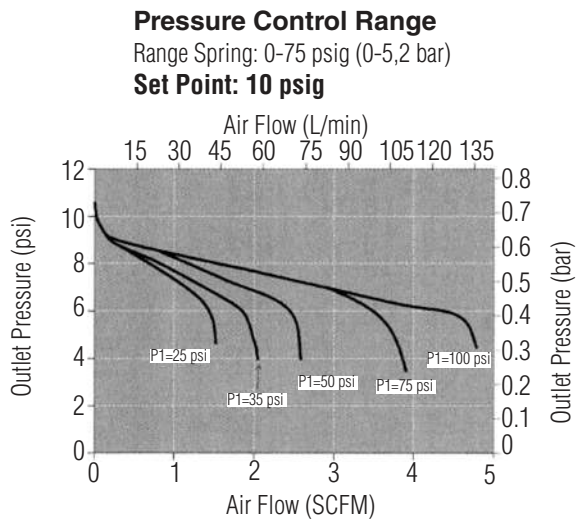
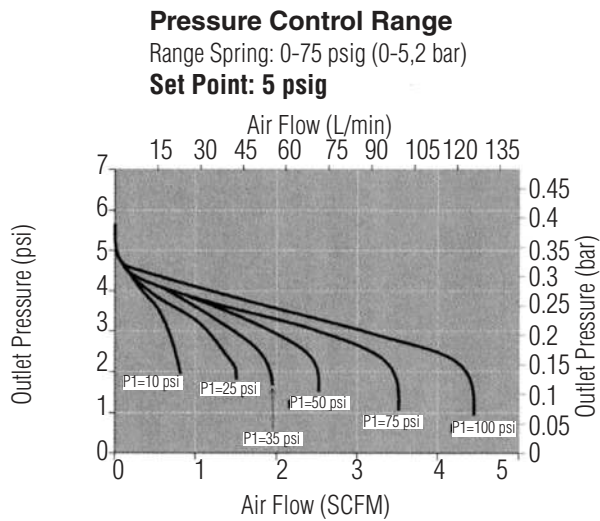
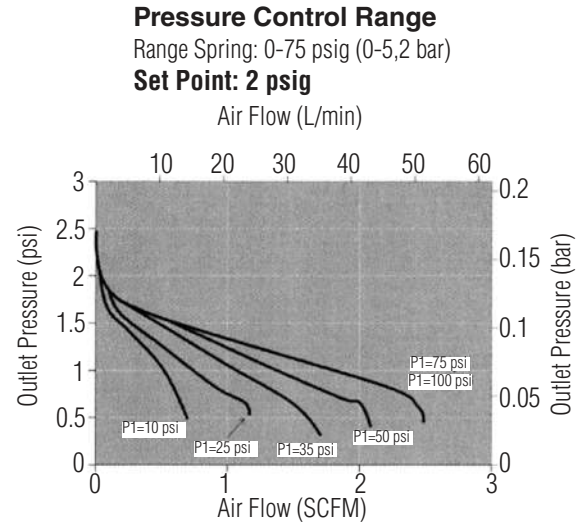
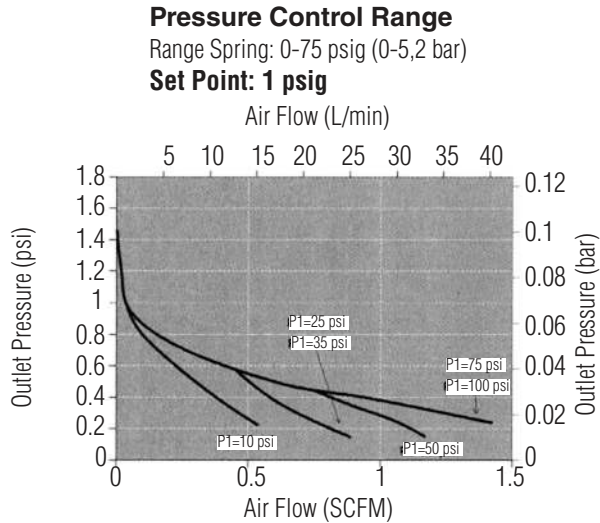

FLOW DATA FOR CV TRIM SELECTION

The graphs illustrate the change or "droop" in outlet pressures as the flow rate increases, and the lockup (setpoint rise) as flow decreases and approaches zero.

Flow Coefficient: 0.08

Maximum inlet pressure: 150 psig (10,3 bar)

Pressure Control Range

Range Spring: 0-75 psig (0-5,2 bar)

Set Point: 25 psig

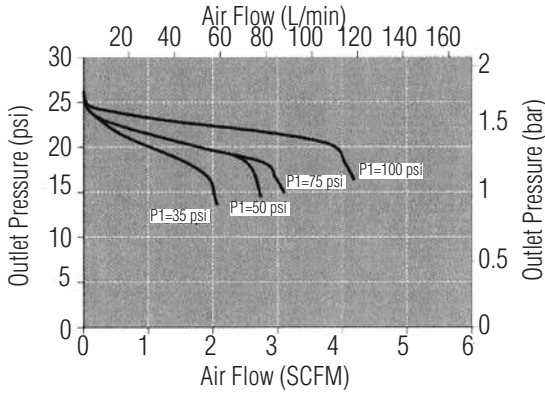

Pressure Control Range

Range Spring: 0-75 psig (0-5,2 bar)

Set Point: 30 psig

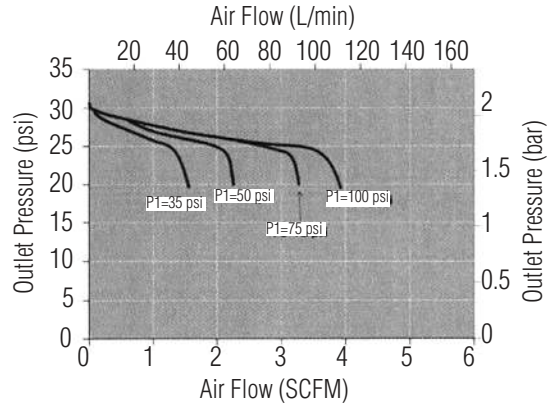

Pressure Control Range

Range Spring: 0-75 psig (0-5,2 bar)

Set Point: 35 psig

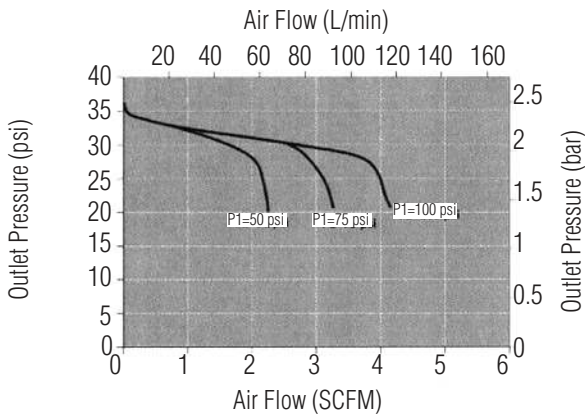

Pressure Control Range

Range Spring: 0-75 psig (0-5,2 bar)

Set Point: 40 psig

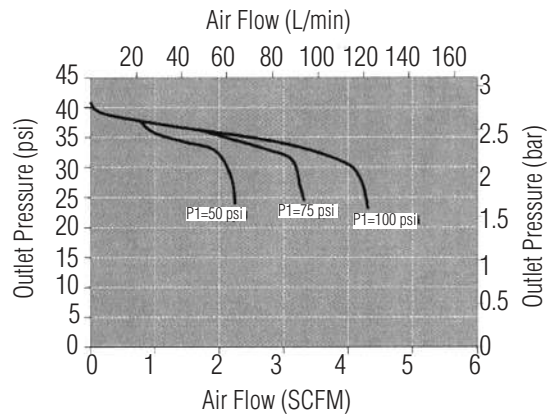

Pressure Control Range

Range Spring: 0-75 psig (0-5,2 bar)

Set Point: 45 psig

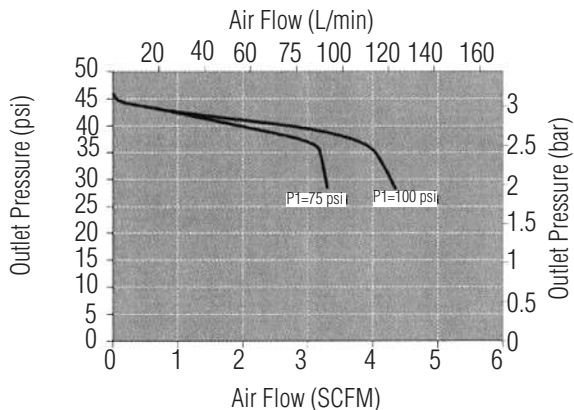

Pressure Control Range

Range Spring: 0-75 psig (0-5,2 bar)

Set Point: 50 psig

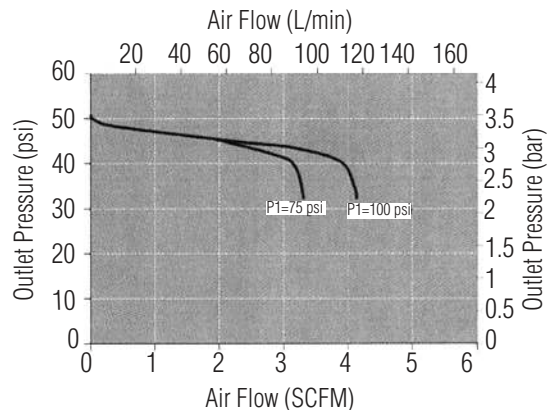

FLOW DATA FOR CV TRIM SELECTION

The graphs illustrate the change or "droop" in outlet pressures as the flow rate increases, and the lockup (setpoint rise) as flow decreases and approaches zero.

Flow Coefficient: 0.08

Maximum inlet pressure: 150 psig (10,3 bar)

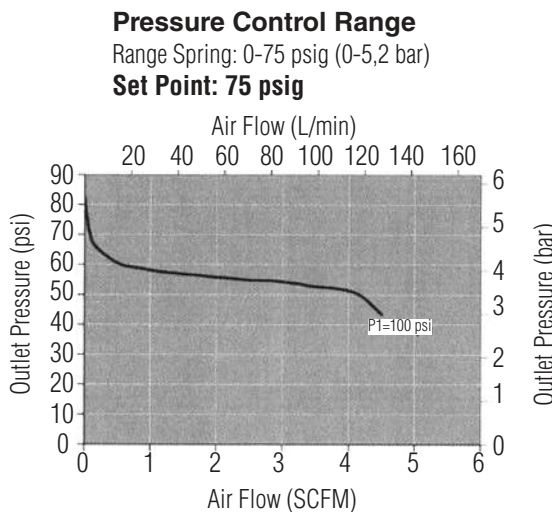
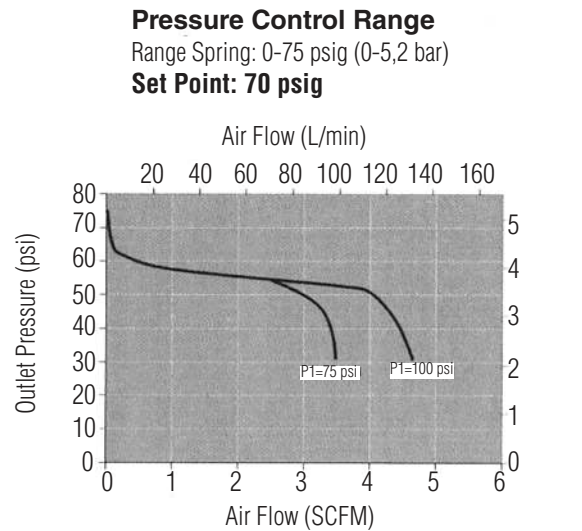
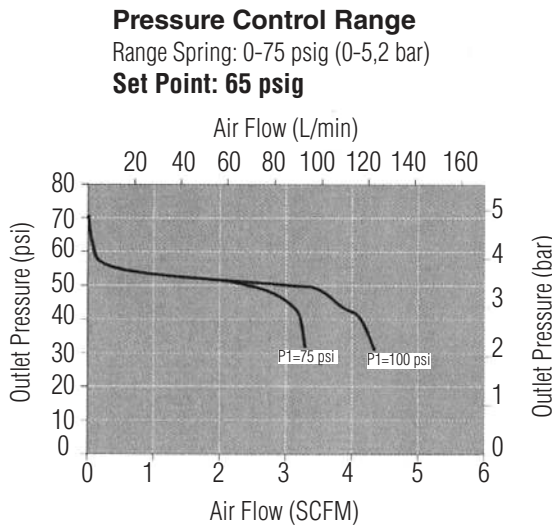
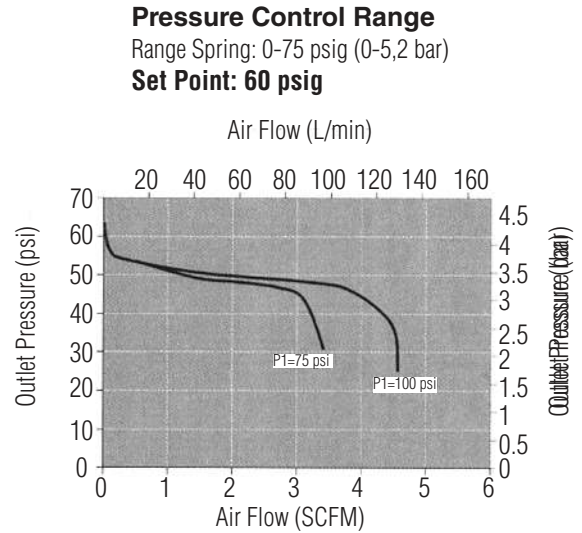
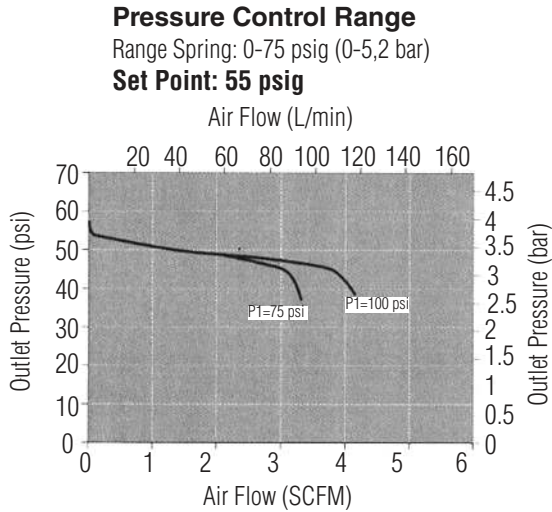

FLOW DATA FOR CV TRIM SELECTION

The graphs illustrate the change or "droop" in outlet pressures as the flow rate increases, and the lockup (setpoint rise) as flow decreases and approaches zero.

Flow Coefficient: 0.20

Maximum inlet pressure: 150 psig (10,3 bar)

Pressure Control Range

Range Spring: 0-75 psig (0-5,2 bar)

Set Point: 1 psig

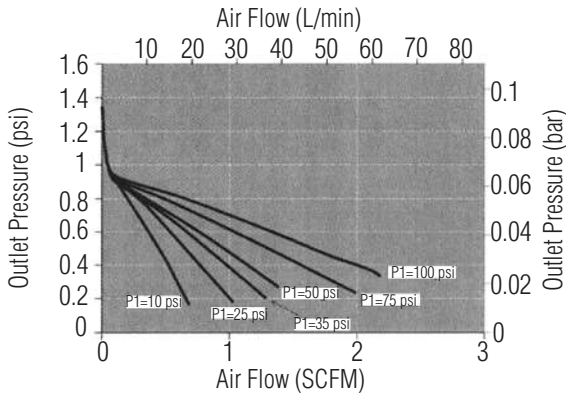

Pressure Control Range

Range Spring: 0-75 psig (0-5,2 bar)

Set Point: 2 psig

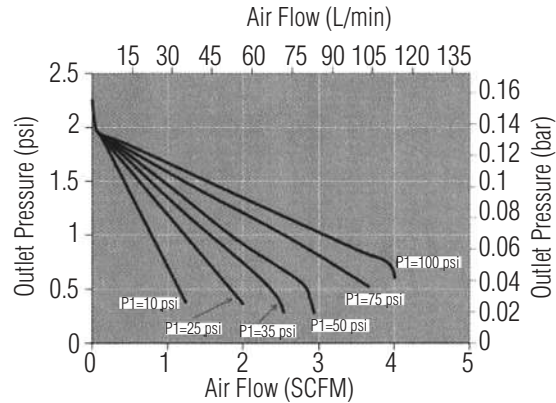

Pressure Control Range

Range Spring: 0-75 psig (0-5,2 bar)

Set Point: 5 psig

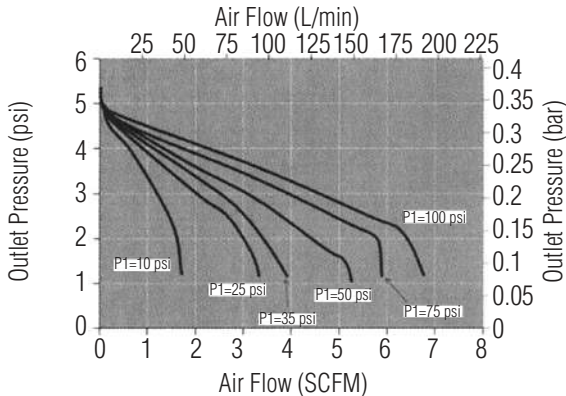

Pressure Control Range

Range Spring: 0-75 psig (0-5,2 bar)

Set Point: 10 psig

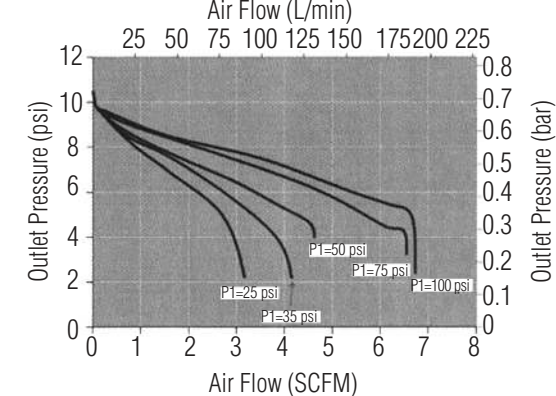

Pressure Control Range

Range Spring: 0-75 psig (0-5,2 bar)

Set Point: 15 psig

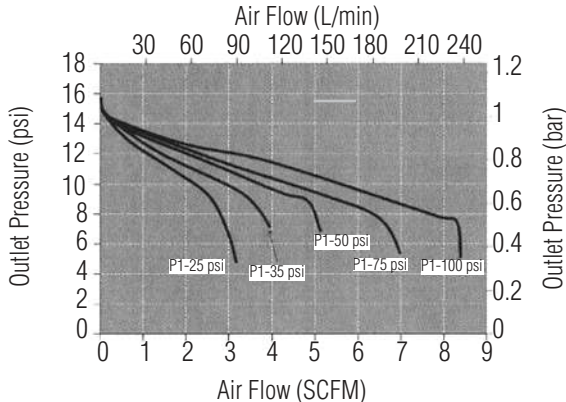

Pressure Control Range

Range Spring: 0-75 psig (0-5,2 bar)

Set Point: 20 psig

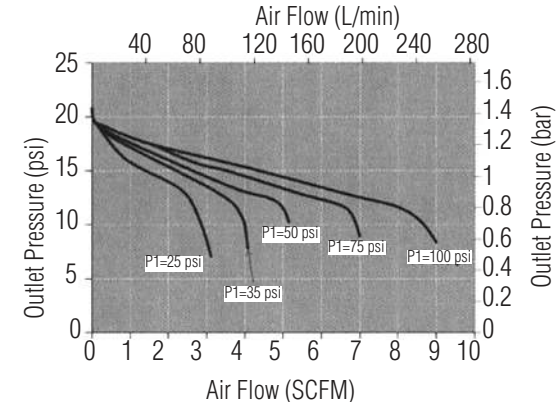

FLOW DATA FOR CV TRIM SELECTION

The graphs illustrate the change or "droop" in outlet pressures as the flow rate increases, and the lockup (setpoint rise) as flow decreases and approaches zero.

Flow Coefficient: 0.20

Maximum inlet pressure: 150 psig (10,3 bar)

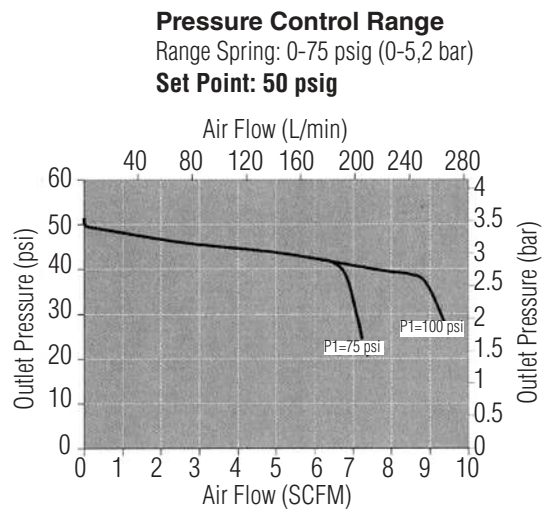
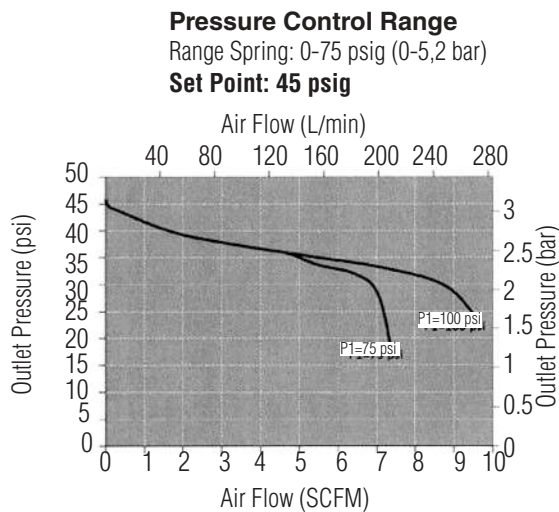
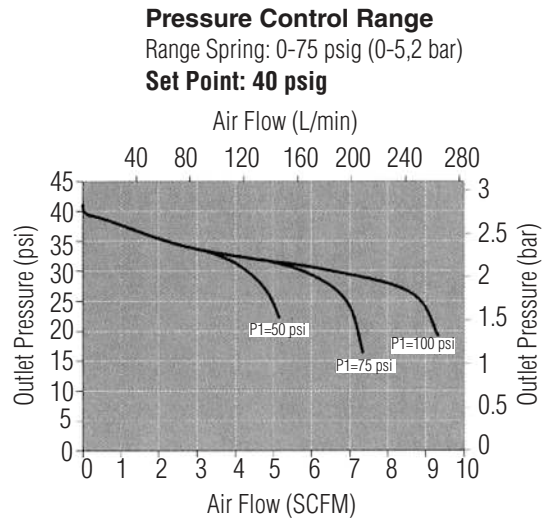
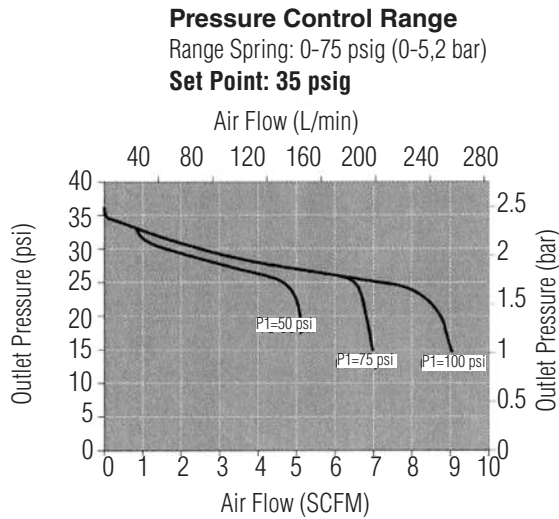
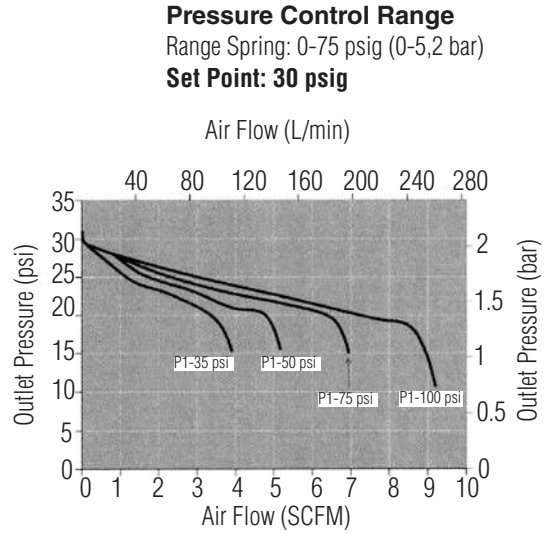
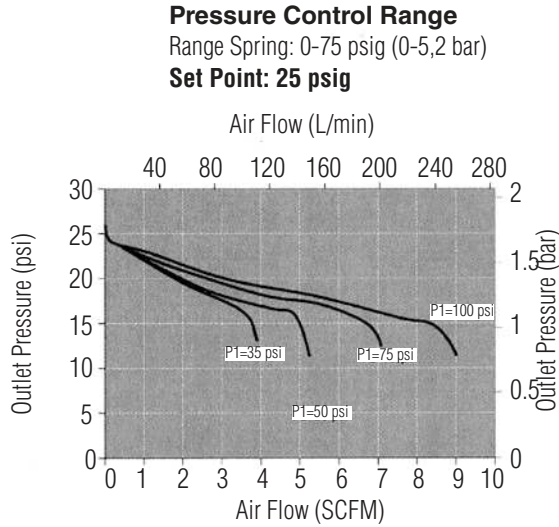

FLOW DATA FOR CV TRIM SELECTION

The graphs illustrate the change or "droop" in outlet pressures as the flow rate increases, and the lockup (setpoint rise) as flow decreases and approaches zero.

Flow Coefficient: 0.20

Maximum inlet pressure: 150 psig (10,3 bar)

Pressure Control Range

Range Spring: 0-75 psig (0-5,2 bar)

Set Point: 55 psig

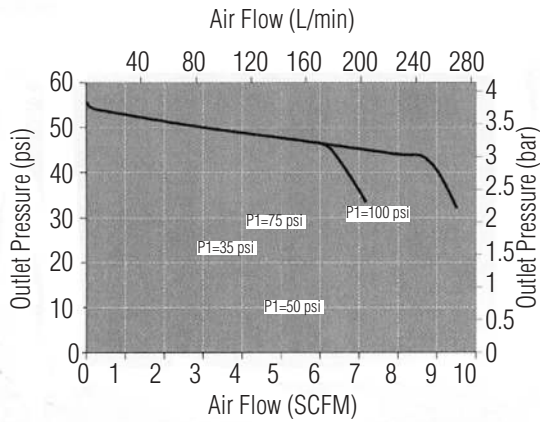

Pressure Control Range

Range Spring: 0-75 psig (0-5,2 bar)

Set Point: 60 psig

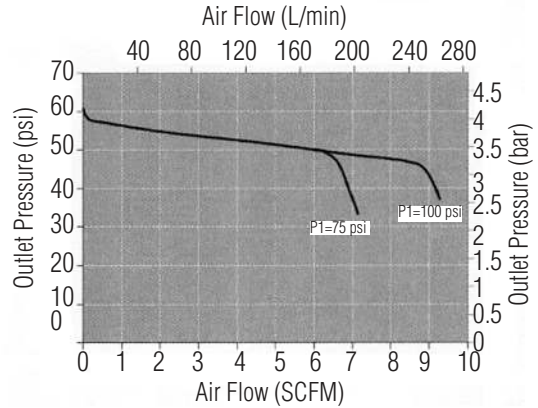

Pressure Control Range

Range Spring: 0-75 psig (0-5,2 bar)

Set Point: 65 psig

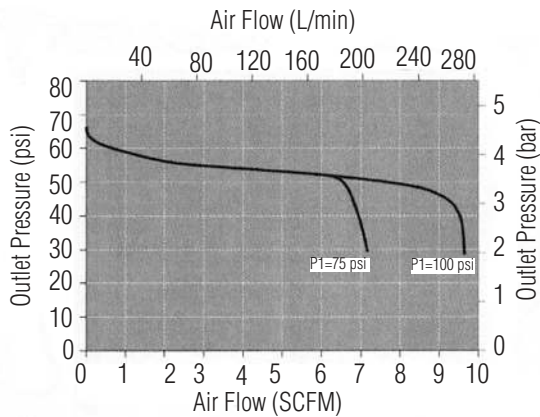

Pressure Control Range

Range Spring: 0-75 psig (0-5,2 bar)

Set Point: 70 psig

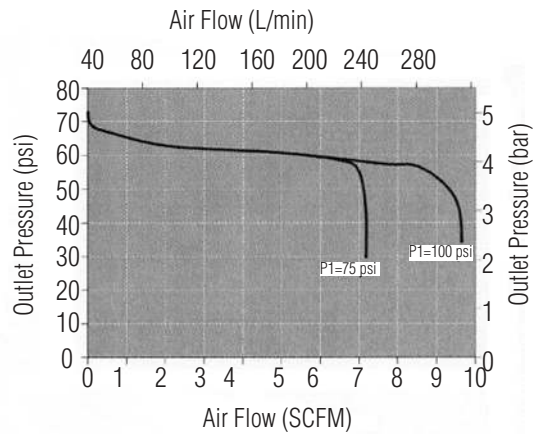

Pressure Control Range

Range Spring: 0-75 psig (0-5,2 bar)

Set Point: 75 psig

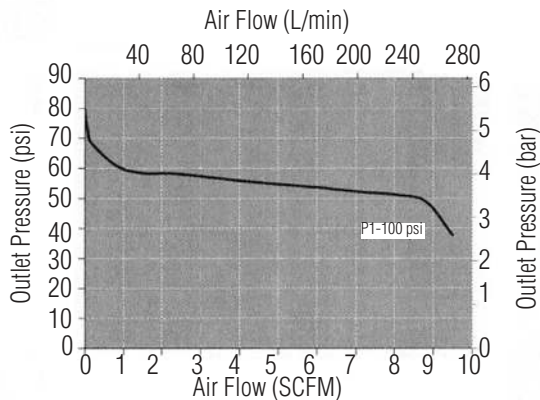

JSRFLP SERIES LOW FLOW LOW PRESSURE REDUCING VALVE

JSRFLP ORDERING SCHEMATIC (SEE PG 22 FOR JSRFLPE (EPDM SEAT) ORDERING SCHEMATIC)

Model	Size	Material	/	1 & 2	3 & 4	5 & 6	7 & 8	9 & 10	11 & 12	13 & 14	15	16	17
	—	—											

Model	
JSRFLP	Low Flow Low Pressure Reducing Valve

Size	
025	1/4" (DN08)
038	3/8" (DN10)
050	1/2" (DN15)

Material	
6L	ASTM A479, 316L

1	Body Feature End Connection	2	Body Feature Port Configuration*
ASME BPE Selections			
A	FNPT, 1/4"	A	Port "A"
B	FNPT, 3/8"	B	Port "B"
C	FNPT, 1/2"	C	Port "C"
T	ASME BPE Tri-Clamp, 1/2"	D	Port "D"
W	ASME BPE Tube Weld, 1/2"	E	Port "E"
ISO Selections			
H ⁴	ISO Tube Weld, DN15	* Std. Gauge Ports are 1/4" FNPT. Contact factory for availability of others	
S ¹	ISO Tri-Clamp, DN15		
V ¹	ISO w/ 34.0mm face T-Clamp, DN15		
R ¹	ISO T-Clamp, DN20		
DIN Selections			
D ²	DIN Tri-Clamp, DN15		
N ²	DIN T-Clamp, DN15 w/50.5mm face		
U ²	DIN T-Clamp, DN20		
X ²	DIN T-Clamp, DN20 w/50.5mm face		
M ³	DIN Tube Weld, DN15		
ZZ	Non-Standard		

¹ Acc. to DIN 32676 Row B (ISO 1127). See dimensions, page 3

² Acc. to DIN 32676 Row A. See dimensions, page 3

³ Acc. to DIN 11866, DIN 11850 Row A

⁴ Acc. to DIN 11866 Row B

3 & 4	Trim
1S	Cv 0.012 (Kv 0,010)
4S*	Cv 0.03 (Kv 0,026)
2S	Cv 0.08 (Kv 0,069)
3S	Cv 0.2 (Kv 0,173)
1R	Cv 0.012 Self-Relieving**
4R*	CV 0.03 Self-Relieving**
2R	Cv 0.08 Self-Relieving**
3R	Cv 0.2 Self-Relieving**
ZZ	Non-Standard

* Though out of sequence, "4S" and "4R" are the correct order codes for Cv 0.03

** You cannot choose the Self-Relieving option, if using the Capture Vent option for Air-Loading. See Page 3 for complete description.

5 & 6	Seat Material - FDA & USP Class VI		
T1	PTFE Cv 0.012	P2	PEEK Cv 0.08
T2	PTFE Cv 0.08	P3	PEEK Cv 0.2
T3	PTFE Cv 0.2	P4	PEEK Cv 0.03
T4	PTFE Cv 0.03	ZZ	Non-Standard
P1	PEEK Cv 0.012		

7 & 8	Range Spring / Outlet Pressure
E1	1 - 75 psi
E2	25 - 100 psi
ZZ	Non-Standard

9 & 10	Diaphragm Material
JL	Jorlon™ PTFE, FDA & USP Class VI
ZZ	Non-Standard

11 & 12	Actuator
	Ranges E1 thru E5
SK	Standard
CV ¹	Captured Vent provides fitting on spring housing for venting self-relieved gas
AA ¹	Air Loading provides fitting for air input on spring housing, and a stem seat nut
PM	Panel Mount
TP	Anti-tamper feature (See illustration page 4)
AK	Anod. Alum.
ZZ	Non-Standard

¹ See page 3 for complete description

13 & 14	Inlet Gauge*
AA	0 - 30 psi / bar (Dual)
BB	0 - 60 psig / bar (Dual)
CC	0 - 100 psig / bar (Dual)
DD	0 - 160 psig / bar (Dual)
NN	None
ZZ	Non-Standard

* Customer assumes all responsibility for possible damage or injury if selected gauge span does not fully cover range spring / outlet pressure option

15	Outlet Gauge*
A	0 - 30 psig/bar (Dual)
B	0 - 60 psig / bar (Dual)
C	0 - 100 psig / bar (Dual)
N	None
Z	Non-Standard

* Customer assumes all responsibility for possible damage or injury if selected gauge span does not fully cover range spring / outlet pressure option

16	SEP Compliance
G	SEP Compliant
∅	None
Z	Non-Standard

Continued on next page...

JSRFLP ORDERING SCHEMATIC (CONT. PG 22 FOR JSRFLPE (EPDM SEAT) ORDERING SCHEMATIC)

Model	Size	Material	/	1 & 2	3 & 4	5 & 6	7 & 8	9 & 10	11 & 12	13 & 14	15	16	17
	—	—											

17	Accessories
S	Clean For Oil Free
X	Clean For Oxygen ³
J	Clean for Oxygen, Assemble Dry ^{2,3}
A	EN10204 3.1 Cert for Wetted Parts
∅	None
Z	Non-Standard

² Procedure complies with ASTM G-93 2011 and CGA G-4.1-2009

³ Use of Oxygen safe lubricant (Krytox™ for example) can affect gas line particulate testing. Assembling all wetted components dry (without lubricant) removes that effect, however it may increase the difficulty in disassembly/reassembly of valve seat components during valve maintenance. Note that we will use O2 safe lubricant on non-wetted threaded components.

JSRFLPE (EDPM SEAT) ORDERING SCHEMATIC

Model	Size	Material	1 & 2	3 & 4	5 & 6	7 & 8	9 & 10	11 & 12	13 & 14	15	16	17
—	—	—	/									

Size	
025	1/4" (DN08)
038	3/8" (DN10)
050	1/2" (DN15)

Material	
6L	Stainless Steel 316L

1	Body Feature End Connection	2	Body Feature Port Configuration*	
ASME BPE Selections				
A	FNPT, 1/4"	A	Port "A"	
B	FNPT, 3/8"	B	Port "B"	
C	FNPT, 1/2"	C	Port "C"	
T	ASME BPE Tri-Clamp, 1/2"	D	Port "D"	
W	ASME BPE Tube Weld, 1/2"	E	Port "E"	
ISO Selections				
H ⁴	ISO Tube Weld, DN15	* Std. Gauge Ports are 1/4" FNPT. Contact factory for availability of others		
S ¹	ISO Tri-Clamp, DN15			
V ¹	ISO w/ 34.0mm face T-Clamp, DN15			
R ¹	ISO T-Clamp, DN20			
DIN Selections				
D ²	DIN Tri-Clamp, DN15			
N ²	DIN T-Clamp, DN15 w/50.5mm face			
U ²	DIN T-Clamp, DN20			
X ²	DIN T-Clamp, DN20 w/50.5mm face			
M ³	DIN Tube Weld, DN15			
ZZ	Non-Standard			

¹ Acc. to DIN 32676 Row B (ISO 1127). See dimensions, page 3

² Acc. to DIN 32676 Row A. See dimensions, page 3

³ Acc. to DIN 11866, DIN 11850 Row A

⁴ Acc. to DIN 11866 Row B

3 & 4	Trim
1S	Cv 0.012
2S	Cv 0.08
3S	Cv 0.2
4S	Cv 0.03
1R	Cv 0.012 Self-Relieving*
2R	Cv 0.08 Self-Relieving*
3R	Cv 0.2 Self-Relieving*
4R	CV 0.03 Self-Relieving*
ZZ	Non-Standard

* You cannot choose the Self-Relieving option, if using the Capture Vent option for Air-Loading. See Page 3 for complete description.

5 & 6	Seat Material
D1	EPDM Cv 0.012
D2	EPDM CV 0.08
D3	EPDM C 0.20
D4	EPDM CV 0.03
ZZ	Non-Standard

7 & 8	Range Spring / Outlet Pressure
E1	1 - 75 psi
E2	25 - 100 psi
ZZ	Non-Standard

9 & 10	Diaphragm Material
JL	Thin Jorlon
ZZ	Non-Standard

11 & 12	Actuator
Ranges E1 thru E5	
SK	Standard
AK	Standard Actuator / Autoclavable Anod. Aluminum knob
PM	Panel Mount (See illustration page 3)
CV ¹	Captured Vent provides fitting on spring housing for venting self-relieved gas
AA ¹	Air Loading provides fitting for air input on spring housing, and a stem seat nut
TP	Anti-tamper feature (See illustration page 4)
ZZ	Non-Standard

¹ See page 3 for complete description

13 & 14	Inlet Gauge*
AA	0 - 30 psig
BB	0 - 60 psig / bar (Dual)
CC	0 - 100 psig / bar (Dual)
DD	0 - 160 psig / bar (Dual)
NN	None
ZZ	Non-Standard

* Customer assumes all responsibility for possible damage or injury if selected gauge span does not fully cover range spring / outlet pressure option

15	Outlet Gauge*
A	0 - 30 psig
B	0 - 60 psig / bar (Dual)
C	0 - 100 psig / bar (Dual)
N	None
Z	Non-Standard

* Customer assumes all responsibility for possible damage or injury if selected gauge span does not fully cover range spring / outlet pressure option

16	SEP Compliance
G	SEP Compliant
∅	None
Z	Non-Standard

17	Accessories
S	Clean For Oil Free
X	Clean For Oxygen ³
J	Clean for Oxygen, Assemble Dry ^{2,3}
A	EN10204 3.1 Cert for Wetted Parts
0	None
Z	Non-Standard

² Procedure complies with ASTM G-93 2011 and CGA G-4.1-2009

³ Use of Oxygen safe lubricant (Krytox™ for example) can affect gas line particulate testing. Assembling all wetted components dry (without lubricant) removes that effect, however it may increase the difficulty in disassembly/reassembly of valve seat components during valve maintenance. Note that we will use O2 safe lubricant on non-wetted threaded components.

Steriflow Valve reserves the right to make revisions to its product, specifications, literature and related information without notice. Please visit our website at www.steriflowvalve.com for the latest information on our products.